

**High Power Multilevel Converters - Analysis, Design and Operational Issues**  
**Dr. Anandarup Das**  
**Department of Electrical Engineering**  
**Indian Institute of Technology, Delhi**

**Lecture – 15**  
**Cascaded H-bridge Converters: Level-shifted PWM**

Now, let us see the Level Shift PWM technique ok. So, we have covered the phase shift PWM and now we will see the level shift PWM.

(Refer Slide Time: 00:31)

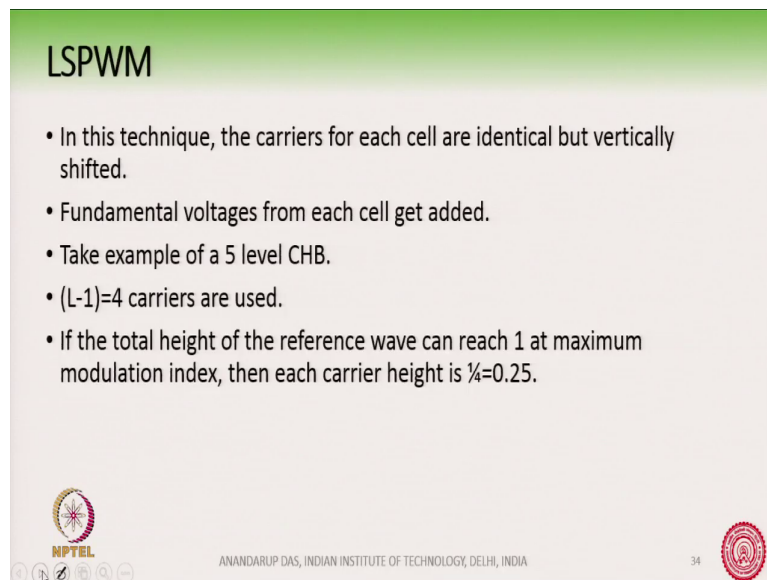

**LSPWM**

- In this technique, the carriers for each cell are identical but vertically shifted.
- Fundamental voltages from each cell get added.
- Take example of a 5 level CHB.
- $(L-1)=4$  carriers are used.
- If the total height of the reference wave can reach 1 at maximum modulation index, then each carrier height is  $\frac{1}{4}=0.25$ .

NPTEL ANANDARUP DAS, INDIAN INSTITUTE OF TECHNOLOGY, DELHI, INDIA 34

In level shift PWM the carriers for each cell are identical ok. Normally, they are all identical some types of LSPWM exist with carriers non-identical, but let us start these carriers, have a being all identical.

(Refer Slide Time: 00:47)

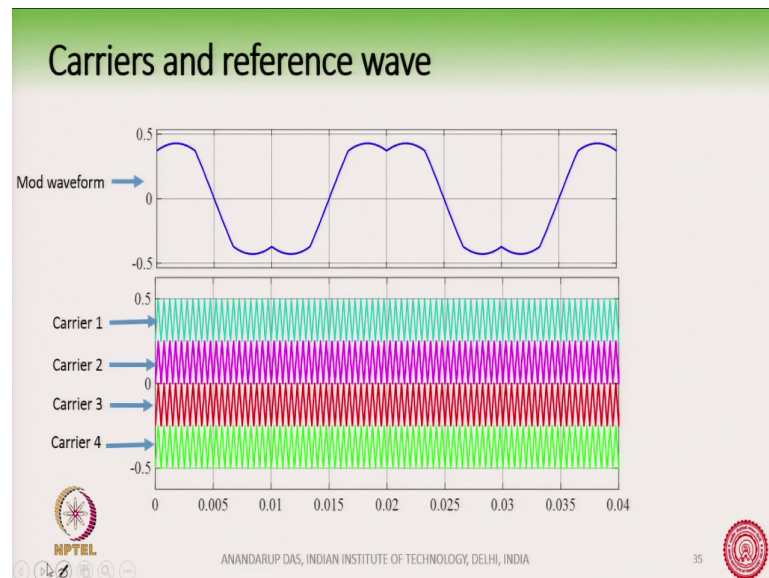

But, they are all vertically phase shifted or vertically shifted from one another. So, you have one carrier here, 2nd carrier here, 3rd carrier here, 4th carrier like that and that is why the term level shift comes, its a level shift PWM. So, you can see so, these are the for example, the carriers ok; carrier 1, carrier 2, carrier 3, carrier 4; where the modulating waveform is shown like this. Its spanning like between minus 0.5 and plus 0.5 and the carriers are also like vertically shifted from one another ok.

(Refer Slide Time: 01:41)

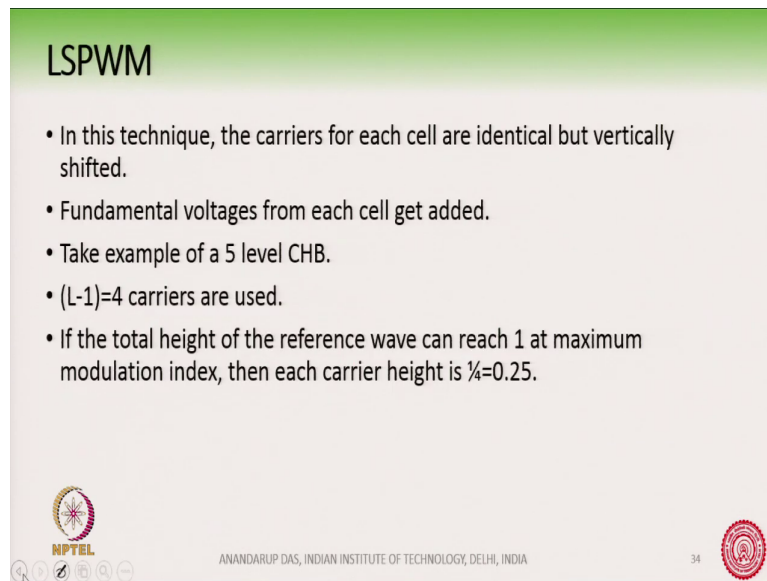

**LSPWM**

- In this technique, the carriers for each cell are identical but vertically shifted.
- Fundamental voltages from each cell get added.
- Take example of a 5 level CHB.
- $(L-1)=4$  carriers are used.
- If the total height of the reference wave can reach 1 at maximum modulation index, then each carrier height is  $\frac{1}{4}=0.25$ .

NPTEL ANANDARUP DAS, INDIAN INSTITUTE OF TECHNOLOGY, DELHI, INDIA 34

So, the fundamental voltage like before in phase shift PWM, the fundamental voltage from each cell gets added up because basically its a series connection of H bridges. So, the fundamental voltages by its connection itself will get added up. Now, let us take the same example as before, take the example of the 5 levels CHB and for a 5 level CHB we will need 4 carriers ok,  $L$  minus 1 4 carriers and these are shown here with the different coloured carriers in this diagram. So, what is the height of each carrier? The height of each carrier if the if suppose the total height of the modulating on the reference wave is 1, then the height of each carrier is 1 by 4 or 1 by the total number of carriers used.

So, it is 1 by 4 is equal to 0.25. So, which means that if this is the modulating waveform its total height is 1, then the height of each carrier is 1 by 4 or 0.25. Basically, the idea is that the carrier should span the entire waveform. So, the entire the waveform is here and the carriers are spanning throughout the waveform ok. Because, ultimately you see the we need to

produce the sine wave and if we do not have the pulse width modulation, we cannot produce the variable voltage which are part of the sine wave. The sine wave is continuously varying and we need the pulse width modulation to mimic or to produce this varying sine wave.

And so, if we so, the carriers must span. So, wherever the modulating wave is present, the carrier should also be present so, that we can replicate the varying nature of the sine wave. So, therefore, the carriers should span the entire height of the modulating waveform.

(Refer Slide Time: 04:11)

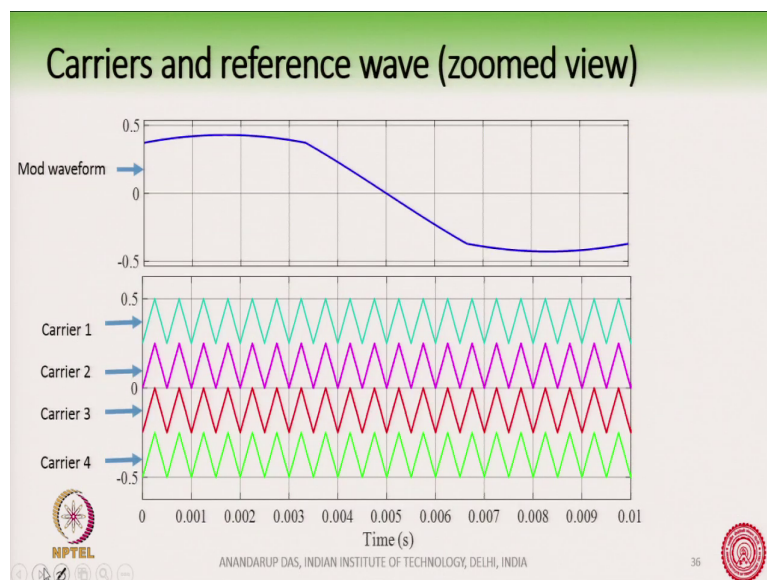

And, here we have shown a zoomed view of the carriers where you can see that these 4 carriers here is they are identical ok, unlike the phase shift PWM. In phase shift PWM these carriers were slightly phase shifted. But, in level shift PWM we see that all these 4 carriers are perfectly exactly same, but they are vertically shifted from each other and that is why it is called level shift PWM.

(Refer Slide Time: 04:52)

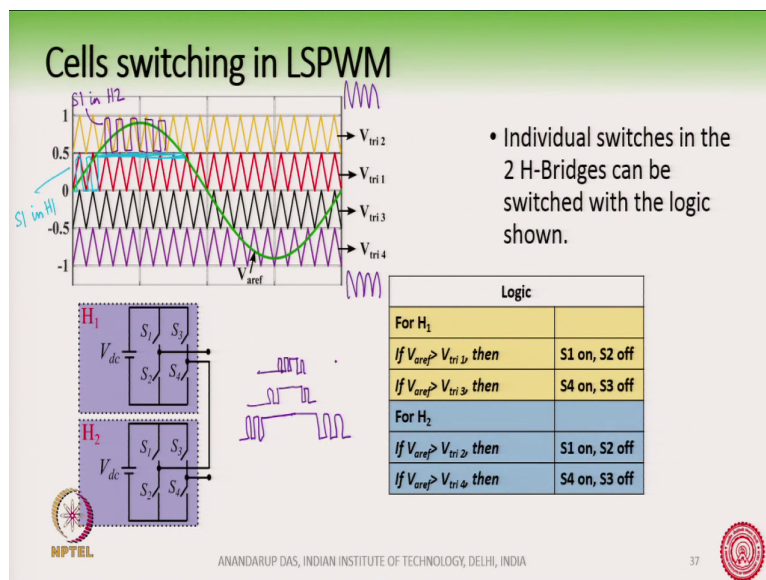

We would like to see exactly how the cell are how the switches in the cells are switching using the level shift PWM technique. So, since this is a 5 level CHB, we have two such cells given by H 1 and H 2. And, there are 4 such triangles which are given now the names triangle 1 2 3 4 here, triangle 1 2 3 4 these are the 4 triangles. Now, this green waveform is the reference waveform. And, what is the logic? So, if we see the cell H 1 here, cell H 1 the triangles which are to be used for cell H 1 will be triangle 1 and triangle 3.

These two triangles will be used to switch the 4 switches for cell H 1 and for H 2 that is this cell for this lower H bridge, we will use V triangle 2 and V triangle 4. So, these two outer triangles we will use. If we had another cell H 3, then we would have used two sets of more triangles; one here another here and of course, the modulating wave will increase. So, what is the logic for switching the 4 switches inside H 1? The logic is given here in this table, if the

reference waveform is more than triangle 1 ok; the reference waveform is more than triangle 1 then we turned on S 1 and of course, S 1 and S 2 are complementary; so, S 2 is off.

So, this is the logic for S 1, if V aref is greater than V triangle 3, then S 4 is on and S 3 is off ok. So, of course, by seeing this two logic you can understand that if V aref is here for example, here if V aref is in this position then S 1 is sometimes turning on and sometimes turning off. Because, V aref is sometimes more than triangle 1 and sometimes less than triangle 1, but V aref is always more than triangle 3. So, during this entire position, during this entire portion of the waveform S 4 will be completely turned on.

So, this is how we get the switching status of all the 4 cells or all the 4 switches in the H bridge H 1. Similarly, here also you can follow the same logic and here you can see that when the reference waveform is here then S 1 is completely turned off, while S 4 is sometimes turned on and sometimes turned off. Similarly, the same logic can be replicated for H 2 which is shown here, if V aref is greater than V triangle 2 then S 1 is on, if V aref is more than V triangle 4 then S 4 is on.

So, if here when we are here during this part of the waveform V aref is sometimes more and sometimes less than triangle 2. And, hence S 1 in H 2 will be sometimes turning on and sometimes turning off. But, for H 1 during this part of the waveform for H 1 what will be the condition of the switches? We see that for H 1 V aref is more than V triangle 1. So, the switch S 1 in H 1 during this portion of the waveform is completely turned on. So, we can see here that if I see switch S 1 then here it is doing this on off, on off and then S 1 completely is turned on here ok. S 1 becomes completely turned on, this portion here because S 1 in H 1 that is what I am saying H S 1 in H 1.

So, this is S 1 in H 1, here it will be sometimes turning on and off that is doing the pulse width modulation whereas, during this portion of time V aref is more than V triangle 1, that is V aref this portion is more than triangle 1. So, it has been completely turned on and during this portion of time; during this portion of time S 1 in H 2 will be doing the pulse width

modulation depending on the on off condition. So, this is the S 1 in H 2 whereas, in this portion S 1 in H 2 will be completely turned off.

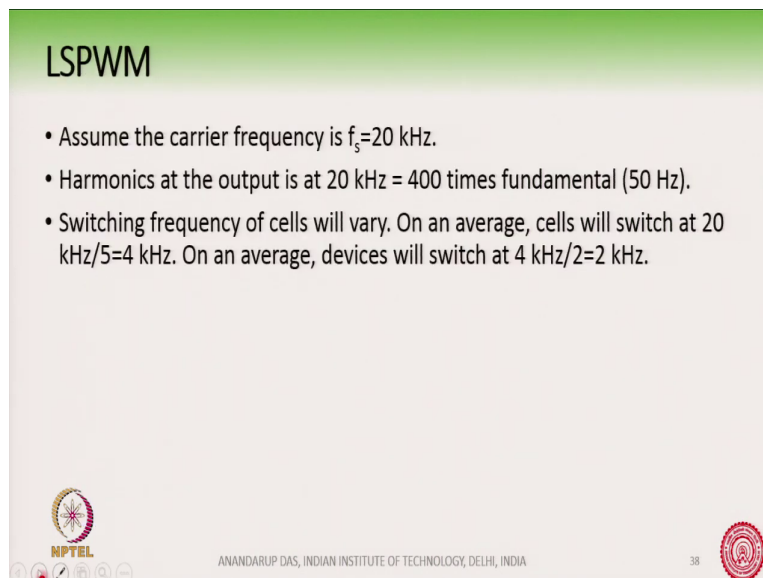

So, it will be turned off at the lower portion. So, you can see here how the voltage of the cells are getting cascaded and how they are supporting each other; one over the other. And, this way if there is one more cell then there will be one more triangle here and one more triangle here. And, then you will see that for one it is like this and then the second one will be like this, third one will be like this; in this way they cascade one over another.

(Refer Slide Time: 12:02)



**LSPWM**

- Assume the carrier frequency is  $f_s=20$  kHz.
- Harmonics at the output is at 20 kHz = 400 times fundamental (50 Hz).
- Switching frequency of cells will vary. On an average, cells will switch at 20 kHz/5=4 kHz. On an average, devices will switch at 4 kHz/2=2 kHz.

 ANANDARUP DAS, INDIAN INSTITUTE OF TECHNOLOGY, DELHI, INDIA 

38

So, the level shift PWM; so, let us take an example just like the previous one assume that the carrier frequency is 20 kilo Hertz ok. Now, the harmonics at the output in level shift PWM will appear at 20 kilo Hertz that is 400 times the fundamental. Now, the carrier frequency here is itself 20 kilo Hertz. So, note the difference between phase shift PWM and level shift

PWM. There the triangular frequency was or the carrier frequency was less 2 kilo Hertz which because, it was equal to the switching frequency of the device.

Here the carrier frequency is 20 kilo Hertz, it is much higher. However, the average switching frequency will be still 2 kilo Hertz or same as phase shift PWM we will see that. So, let us see that if the carrier frequency is 20 kilo Hertz then the harmonics will reside at 400 times the fundamental, but the switching frequency of cells will vary. On an average cells will switch at 20 kilo Hertz divided by 5, because there are 5 number of cells so, it will come around 4 kilo Hertz. And, on an average devices will switch at 4 kilo Hertz divided by 2, that is 2 kilo Hertz ok.

So, the device switching frequency in both cases remain the same, but in phase shift PWM the carrier frequency is equal to the device switching frequency. And, in level shift PWM the carrier frequency is equal to the effective output switching frequency; so, that is what this slide shows.



(Refer Slide Time: 14:06)

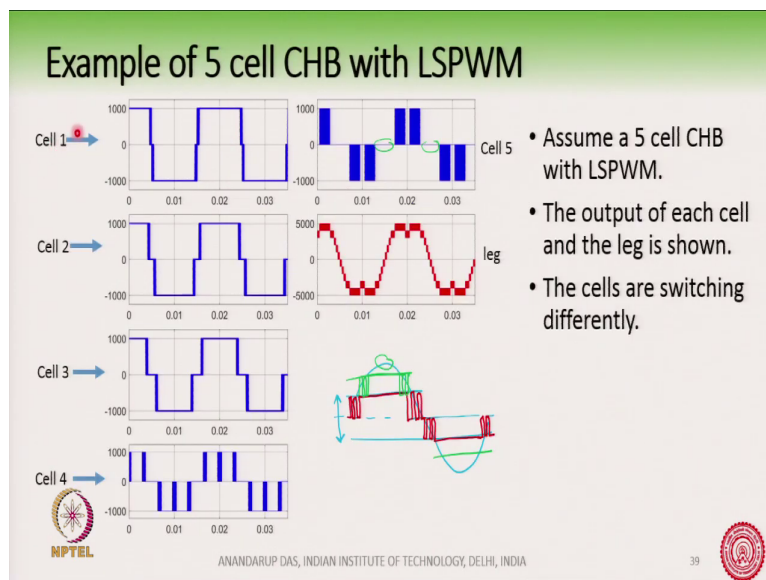

So, let us take and see this example that for example, we have 5 cells CHB and we are taking the level shift PWM strategy and the output of each cell is shown here. So, for example, the output of cell 1 is something like what is shown here, output of cell 1 ok. Why the output is looking like this? This is because say as I have told you earlier; so, this is the sine wave I am trying to do trying to produce like this one. So, cell 1 is kind of like taking the responsibility of producing one part of the waveform. So, cell 1 say for example, cell 1 is producing this the waveform here.

So, of course, it means that sorry of course, it means that the cell 1 will do a pulse width modulation here or switching here and here and the rest of the time it will be just turned on fully and so, that it can support the next cell ok. Similarly, at the negative side it will be like this and then fold it like this and then it will do the switching here. This is what is this waveform here, you can see this is the switching area and then it is clamped, cell 1 is

clamped. And, then again the switching same like this here, cell 2 for example, will be taking this part of the waveform.

So, it will be switching here and then it will subsequently get clamped and this is what cell 2 is shown here, you see this part till this part it was; so, then means I kind of like cell 2 sits over the top of cell 1 and subsequently cell 3 sits over the top of cell 1. So, in this way you can see for example, cell 5 does not switch here, its just 0 because it was waiting for cell 1 cell 2 cell 3 cell 4 to come up to that topmost region here and then it is switching there ok. So, you can just pictorially see or visualize how these cells are stacking, how their waveforms are stacking up one over another.

(Refer Slide Time: 17:04)

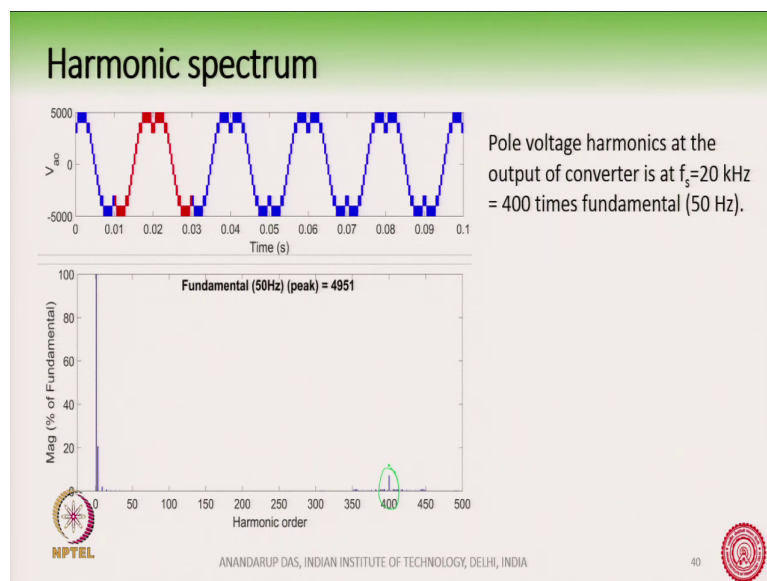

So, the harmonic spectrum if you see its again similar ok. So, the pole voltage harmonics again the output voltage is 4951 volt and the fundamental is kind of 100 percent, there is a

3rd harmonic and there is no other there is triple n harmonics 3rd, 9th, 15th. There is no harmonics in between and the 1st band exists at 400 times the fundamental that is 20 kilo Hertz.

(Refer Slide Time: 17:47)

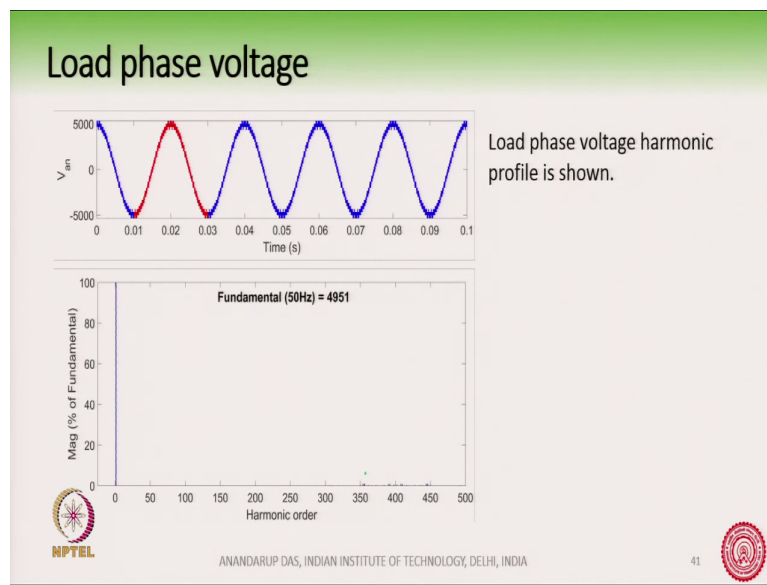

So, the load phase voltage exactly like before the harmonic side bands exists around 400 here and the triple n harmonics have disappeared, triple n harmonics have disappeared here and all harmonics at 400 times the fundamental.

(Refer Slide Time: 18:08)

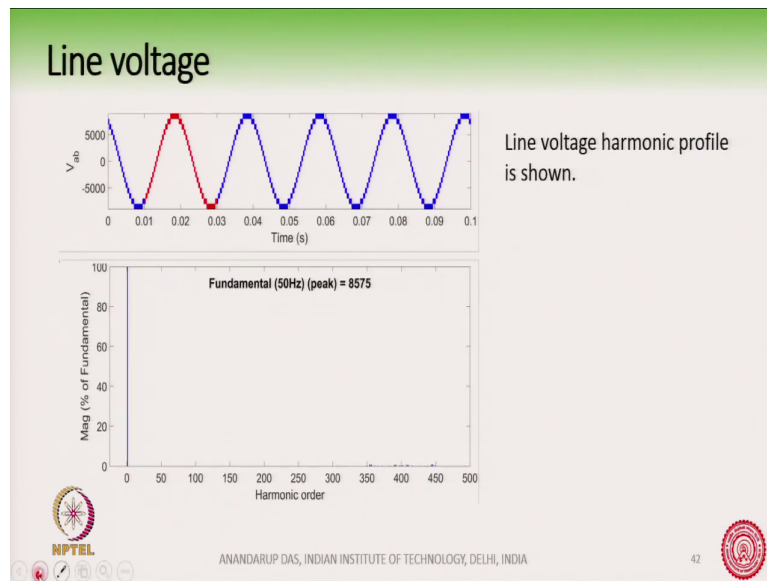

Line voltages also does not have the triple n harmonics anymore, the line voltages root 3 times the peak phase voltage magnitude.

(Refer Slide Time: 18:21)

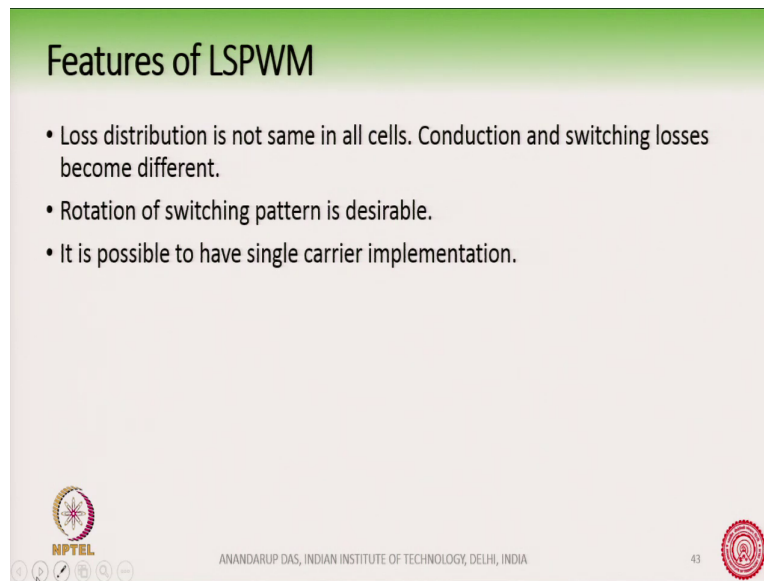

### Features of LSPWM

- Loss distribution is not same in all cells. Conduction and switching losses become different.
- Rotation of switching pattern is desirable.
- It is possible to have single carrier implementation.

NPTEL ANANDARUP DAS, INDIAN INSTITUTE OF TECHNOLOGY, DELHI, INDIA 43

Now, when you see the level shift PWM, we find that the loss distribution is not same in all the cells, conduction and switching losses are different. This is very easily understood from this waveform here, if you compare the output waveform of cell 1 and cell 5, you can very readily see that the losses the losses of cell 1 and cell 4 are markedly different. For example, cell 1 has a switching loss here and a conduction loss here because it is clamping the voltage there. So, there is a conduction loss whereas, cell 5 is not switching at all its 0 voltage here and there is a lot of switching here.

So, level shift PWM causes an unequal distribution of losses in all the cells, you can see the cell 2 cell 3 cell 4 depending on the power factor also the losses will get substantially different ok. So, but this is not the case with phase shift PWM, in phase shift PWM the waveforms produced by each cell were almost identical. There was a slight phase shift, but that slight phase shift does not cause much change in the losses, but here the waveforms are

dramatically different for each cell. And so, the losses will substantially differ in terms of switching and conduction losses.

And, this is something which is a problem because, then because as we have said cascaded H bridge is built on the principle of modularity. So, we have a same heat sink design for all the cells. So, if one cell is heated up substantially then its lifetime or it will have a thermal over trip or its lifetime will be reduced. So, what to do? How to overcome this challenge? Because, the pattern we can see the pattern is present in front of us and it is causing an unequal distribution of losses. So, what can be done? Remember so, the easy solution here is to rotate the patterns after few cycles. Rotate the patterns what does it mean?.

You see here cell 1 has this pattern of waveform and cell 5 has this pattern of waveform. But, after a few cycles we can interchange their pattern for example, cell 5 can be asked to produce this waveform and cell 1 can be asked to produce this waveform. It does not matter how their patterns are getting interchange because, ultimately the output voltage does not get changed because, it is a series connection of cells.

So, if I ask cell 5, if I ask cell 5 to produce this waveform after say 1 second and if I asked cell 1 to produce this waveform keeping cell 2 cell 3 cell 4 as same for example. Then the output voltage will remain same as before ok. But what will happen? The loss distribution the division of losses what was happening in cell 1 and cell 5 will now get interchanged. So, if we go on doing this, this rotation of pattern say I asked cell 1 to take this pattern for 1 2nd.

And, then after 1 2nd I asked cell 1 to take this pattern, I asked after 1 2nd I ask cell 1 to take this pattern and then this pattern and then this pattern. Then over say 5 2nds I have asked cell 1 to go through all this patterns so, that the loss distribution becomes same for all the cells. So, in this way by doing this rotation of the pattern or rotation of cells we can ensure that the loss distribution in all the cells over a span of time becomes almost equal ok.

This is what we have seen that the loss distribution is same not same in all the cells, but by rotation of the switching pattern we can make the losses almost same. There is one more

thing that one more feature of LSPWM which is interesting is that instead of having 4 or 5 carriers, we can also have a single carrier implementation in level shift PWM.

(Refer Slide Time: 23:37)



So, which you can see here single, carrier implementation. Why this single carrier implementation? See, these carriers as I had earlier shown you that for example, if there was a mod modulating waveform like this and there were like 4 carriers we had seen example few minutes back, there were 4 carriers. Now, this 4 carriers instead of using 4 carriers we can use only one carrier ok, like this one here. This is the only a single carrier which can take care of this modulating waveform. Why this single carrier is useful is particularly it is useful in case of when we are working with DSPs.

Because, DSPs these carriers are generated in DSPs using counters ok, up down counter will create a sawtooth, waveform sorry the triangular waveform and only a up counter or only a

down counter will create a sawtooth waveform. So, the counter goes on incrementing on every clock cycle of the DSP. The DSP has limited number of counters ok, say modern DSPs are actually having a lot of counters, modern DSPs can have 6 independent counters, but earlier days they had only 1 counter for example, 1 or maybe 3 counters.

So, it was useful to have this the implementation of LSPWM using only one carrier, then the 1 counter of the DSP was good enough to do the LSPWM. So, when we use a single carrier then what we do is we have to bring the whole modulating waveform inside one carrier and this is shown here, this middle waveform. So, if we have this waveform, if I draw the carrier say if I draw the carrier for example, this is the lowest carrier ok, this is the lowest carrier right. So, whenever so, if I want to implement these are the 4 carriers, here there is a 2nd carrier, 3rd carrier and then the 4th carrier not shown.

So, we are not going to use these 4 carriers, but instead we will be using a single carrier ok. So, if I do have to do it, what I have to do? I have to bring the modulating waveform inside the carrier. So, how do I bring that? So, wherever the modulating waveform is crossing the carrier we actually bring it inside the carrier by doing a shift ok. So, for example so, this is the modulating waveform and we will bring it inside one carrier. So, the modulating waveform is actually crossing the boundary of the lowermost carrier at these two points; so, if I have to bring it down ok.

So, what is so, whenever it is going up here I will push it down here and bring it inside the carrier and keeping in mind that I have done a single push in this case. So, I have pushed it down. So, this you see the this is the; this is the waveform here and I have done a push down and it is bringing inside one carrier because, I want to implement the whole logic using a single carrier from the DSP. So, I have pushed it down and kept in mind that one push or one level shift has been done. Ideally, it would have been done by the 2nd carrier, but since I do not have the 2nd carrier; I am actually pushing or I am bringing the modulating waveform inside the green carrier which I have shown here.

So, I am pushing it down. So, there is one shift; so, with one shift I have; so, this waveform goes like this and that is why this waveform goes like this which is here shown. So, when it



crosses the 2nd case; so, this is the boundary of the 2nd carrier and then we go to the 3rd carrier. So, then I have to do two shifts or two pushes down. So, from there this part of the waveform here I will push it down inside the green one and that is what this is doing here two shifts. This part of the waveform is obtained by this is basically this part two shifts down.

And, the last part is where this part where the 4th carrier resides, here is the 4th carrier resides, here the 4th carrier. The whole part of this waveform, this waveform whole part of it, this part here will be fully pushed down inside the green one that is what this push has done. This is the; this is the shifted waveform ok. So, I push this whole thing down so, that now this is the new modulating waveform and this modulating waveform will be compared with the carrier like this which is this carrier here ok. So, with so the modulating the new modulating waveform is like this here, like this.

So, then with this shifting or with this pushing of the carrier with the pushing of the modulating waveform, it is possible to bring the modulating waveform inside one carrier and helps in the implementation with DSP.

(Refer Slide Time: 30:34)

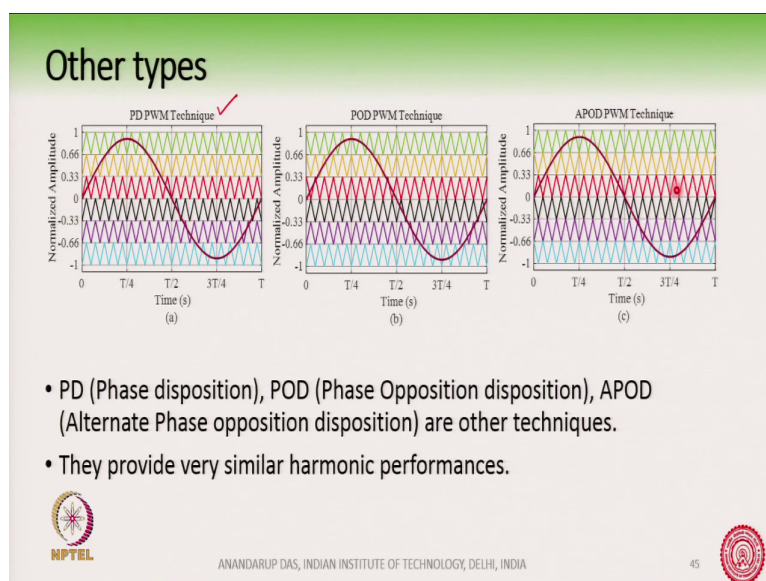

Now, there are as I told you there are some other types of level shift PWM techniques, whatever we have talked about is called the phase disposition PWM, level shift PWM which is this one here ok, on the leftmost side. And, this one you see all these carriers are identical, but they are just vertically phase shifted ok. There are other techniques also like phase opposition disposition PWM, where you see these three carriers are identical, but vertically shift phase shifted.

But, these three lower ones are 180 degree phase shifted to the top ones, this one, this one, this one these are 180 degree phase shifted to the top ones. Then there is also something called as alternate phase opposition disposition. So, the these two carriers alternate carriers are 180 degree shifted like this ok. So, there are some more techniques also and all these techniques have very similar harmonic performances.

But, as regarding so, there will be some minor changes in the ripples because of this different techniques and sometimes they are useful. But, we will stick to the phase disposition PWM level shifted PWM in this course.

(Refer Slide Time: 32:12)

### Measurement of harmonics

- Measurement of harmonics is given by Total Harmonic Distortion (THD).
- THD is the ratio of the rms values of all the harmonic components of a signal to the rms value of the fundamental.
- THD of a voltage can be given as, 
$$\text{THD} = \frac{\sqrt{\sum_{h=2}^{h=n} \left(\frac{V_h}{V_1}\right)^2}}{1} = \frac{\sqrt{V_2^2 + V_3^2 + V_4^2 + \dots + V_n^2}}{V_1}$$
- THD is not an accurate depiction of harmonics from voltage source converters. Weighted THD is a more suitable expression.
- $$\text{WTHD} = \sqrt{\sum_{h=2}^{h=n} \left(\frac{V_h/h}{V_1}\right)^2}$$

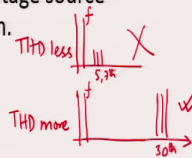

NPTEL ANANDARUP DAS, INDIAN INSTITUTE OF TECHNOLOGY, DELHI, INDIA 46

Now, this is the last thing, how do we measure this harmonics? The measurement of harmonics is or how do we quantify the harmonics? The harmonics are quantified by Total Harmonic Distortion: THD. And so, what is THD? THD is the ratio of the rms value of all the harmonic components to the rms value of the fundamental; so, this is the definition of THD. So, you see the contribution of all the harmonics divided by the contribution of the fundamental ok; so, this is what expanded is this here. Now, although THD is an important parameter for voltage source converters, but it is not the most accurate depiction of harmonics.

Why? Because, the position of harmonics are also very important in voltage source converters ok, apart from the contribution of the harmonics. So, for example, suppose I have to I have a voltage source converter and I have PWM techniques, in one PWM technique the output voltage. So, this is the fundamental and these are the some harmonics which I have produced and this is say around 5th, 7th these harmonics which I have produced here and this is the fundamental ok. In another PWM technique, in another PWM technique say this is the fundamental same as before I have produced.

But, I have produced some harmonics here which is say at 1 kilo Hertz or like about not 1 kilo Hertz I will say around 30th harmonics, around 30th for example. But, the amplitude of these harmonics are more than the amplitude of this one ok. If you now do the THD ok, if you now do the THD analysis of this, you will see that THD is more here and THD is less here ok. THD is more because the 30th harmonics, they can the amplitude of those harmonics are much higher whereas, the THD is less because, these are harmonics having less amplitude, although they are very close to the fundamental.

In the 2nd case there is no harmonic which is close to the fundamental. Now, if you go by the definition of THD of course, we want the THD to be as less as possible then we are close to the fundamental. Harmonic contribution is less, if THD is less the harmonic contribution is less whereas, if THD is more the harmonic contribution is more. So, we will say let us choose this one, but actually this is not good because the lower harmonics the 5th, 7th harmonics these are more detrimental ok, these are more problematic.

For example, 5th harmonic, 7th harmonic causes 6th harmonic torque pulsation in that induction motor ok. So, this is never a good idea because although the amplitude of 5th and 7th are small, but they are very close to the fundamental. And, this closeness is something which must be avoided. In the 2nd case we have harmonics around 30th and they can be relatively easier, they are easier to filter out by choosing a cut off frequency whereas, for 5th and 7th it is very difficult to filter them out or we need a very very big filter. So, this 30th harmonics are relatively easier to filter out.

So, therefore, this harmonic spectrum, the converter which produces voltage and whose harmonic spectrum is like this, this is the one which must be chosen. And, this should be avoided, this should never be used or as far as possible tried to try to be avoided, this must be avoided this one and this is better. So, therefore, THD is not an accurate this depiction of harmonics from voltage source converter, instead we use weighted THD. It is a more suitable, where the weight the weight of the harmonics has a role to play that is the position of the harmonics ok.

So, therefore, the higher it goes, lesser is the contribution ok. So, if  $H$  is high then the contribution of that harmonics goes down because, it can be easily filtered out; for example, by the inductance of the motor. So, weighted THD is actually a more suitable description. So, when you compare a voltage source converters in terms of harmonic performance weighted THD is a more suitable expression.