

**Advance Power Electronics and Control**  
**Prof. Avik Bhattacharya**  
**Department of Electrical Engineering**  
**Indian Institute of Technology – Roorkee**

**Lecture - 36**  
**Power Quality Mitigation Devices - II**

Welcome to our lectures on advance power electronics and control. We shall continue to discuss with the power quality mitigations devices which we have started in our previous lecture. Now effect of the actually power quality problem on the users, so power quality problem affects all the concerned utilities as I was discussing at the starting of the previous class.

**(Refer Slide Time: 01:03)**

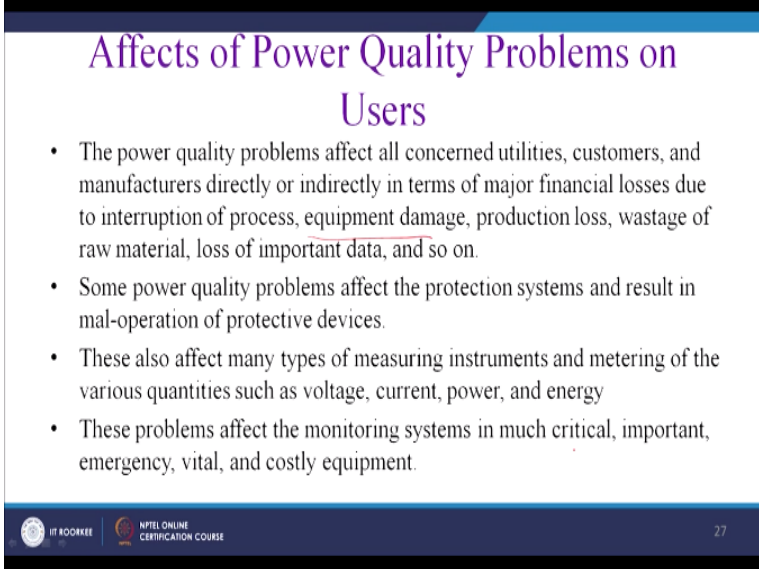

**Affects of Power Quality Problems on Users**

- The power quality problems affect all concerned utilities, customers, and manufacturers directly or indirectly in terms of major financial losses due to interruption of process, equipment damage, production loss, wastage of raw material, loss of important data, and so on.
- Some power quality problems affect the protection systems and result in mal-operation of protective devices.
- These also affect many types of measuring instruments and metering of the various quantities such as voltage, current, power, and energy
- These problems affect the monitoring systems in much critical, important, emergency, vital, and costly equipment.

IIT ROORKEE    NPTEL ONLINE CERTIFICATION COURSE    27

That customer, manufacturer directly or indirectly in terms of the major financial losses due to the interruption of the process, equipment damage, production loss, wastage of the raw material, loss of important data and so on. Some power quality problem affects the protection system and the results in the mal-operation of the protective devices mainly delay sometime malfunction due to this actually the power quality problem.

This may also affects many types of measures and instrument of metering and various quantities such as voltage, current and energy. These are the great problem on the power system due to the power quality. This problem affects the monitoring systems is much critical important and vital and we require costly equipment to manage it.

**(Refer Slide Time: 01:55)**

## PQ Problems Mitigating devices

- The custom power devices for the mitigation of power quality problems are power filters of various types such as active, passive, and hybrid in shunt, series, or a combination of both configurations (UPQC) in single-phase two-wire, three-phase three-wire, and three-phase four-wire systems.
- Power quality improvement techniques used in newly designed and developed equipment, also known as IPQCs, multi-pulse AC-DC converters, matrix converters for AC-DC or AC-AC conversion, and so on, which inherently mitigate some of the power quality problems.



Now we require to mitigate these power quality problems, so from this discussion we have understood the type of the power quality problems and how it will affect us and how it can be mitigated. The custom power devices for mitigations of the power quality problems are power filters. We have studied the filters with an op-amp, so it can actually resist active filter but it can handle a power in range of the watt but you may have to actually tackle the power in the range of the megawatt.

For the various types of the active, passive and the hybrid in shunt, series or a combinations of the filter and UPQC that is unified power quality conditioner in single-phase two-wire, three-phase there are different permutation combinations, single-phase two-wire, three-phase three-wire, three-phase four-wire are possible. Power quality improvement technique is used in newly designed and developed components such as IPQC.

Students are requested to refer my facts lectures for IPQC has been discussed in detail. Multi-pulse AC to DC converters, matrix converter for AC to DC and AC to AC conversion and also which inherently mitigate some of the problem of the power quality.

**(Refer Slide Time: 03:33)**

## Passive filters

- As nonlinear loads, the solid-state converters draw harmonics and reactive power components of current from the AC mains.
- The injected harmonic currents, and reactive power burden, cause low system efficiency and poor power factor.
- Traditionally, passive power filters (PPFs) are used to reduce harmonics and capacitors are generally employed to improve the power factor of the AC loads
- In medium and low power ratings, especially in distribution systems, the passive filters are used again because of their low cost and simplicity
- The passive filters are classified into many categories such as shunt, series, hybrid, single tuned, double tuned, damped, band-pass, and high pass.



So first we shall start with the oldest solution that is the passive filters. The nonlinear loads, the solid-state converters draw harmonics and the reactive power components, currents from the AC mains. The injected harmonic current and reactive power burden cause low system efficiency and poor power factor. Traditionally, passive power filters that is PPFs are used to reduce harmonics and capacitors are generally employed to improve the power factor of the AC loads.

The medium and low power factor ratings especially in distribution system. The passive filters are used again because of their low cost and the simplicity but there are many drawbacks of this actually the passive filters. This passive filters are classified into many categories such as shunt, series hybrid, single tuned, double tuned, damped, band-pass, high pass, we will see the figure in next few slides.

Drawbacks, basically these devices will derate with the time and thus when you have tuned a particular frequency, it is no longer working that and it will actually work at other frequency. Thus, response will be nullified gradually due to (()) (05:11).

**(Refer Slide Time: 05:15)**

## Passive filters (Cont...)

### Drawback

- Because of the low value of power capacitors in passive filters, these filters become very sensitive to the parallel resonance between filter capacitors and source impedance (mainly inductive in nature).
- If the parallel resonance frequency occurs at or near a harmonic produced by the load, a severe voltage distortion and a harmonic current **amplification** may be produced.
- However, if the passive filters are used along with a small active filter that blocks or avoids such parallel resonance



Because of the low value of the power capacitors in the passive filters, these filters become very sensitive to the parallel resonance between filter capacitors and the source impedance and mainly it is inductive in nature. If parallel resonance frequency occurs at or near harmonic produced by the load, a severe voltage distortion and the harmonic current amplification may be produced.

So this is quite dangerous. However, passive filters are used along with the small active filter that blocks or avoids the parallel resonance. So this is something we have to keep in mind.

**(Refer Slide Time: 06:01)**

## Passive filters (Cont...)

- Passive filter topology can be classified based on the topology, connection, and the number of phases.
- The topology can be shunt, series, and hybrid and further sub classified as tuned and damped to act as low-pass and high-pass for shunt filters or to act as low-block and high-block for series filters.
- Other major classification is based on the number of phases such as single-phase (two-wire) and three-phase (three-wire or four-wire) PPFs with these supply systems.



Passive filter topology can be classified based on the different kind of connections and number of phases. The topology can be shunt, series and hybrid and further sub classified as tuned or damped acts as a low-pass filter or high-pass filter or shunt filter or acts as a low-

block or the high-blocks for the series filters. We shall see the details, all the discussions. Other major classifications are based on the number of the phases like single phase two-wire system, three-phase three-wire or four-wire or PPFs.

**(Refer Slide Time: 06:47)**

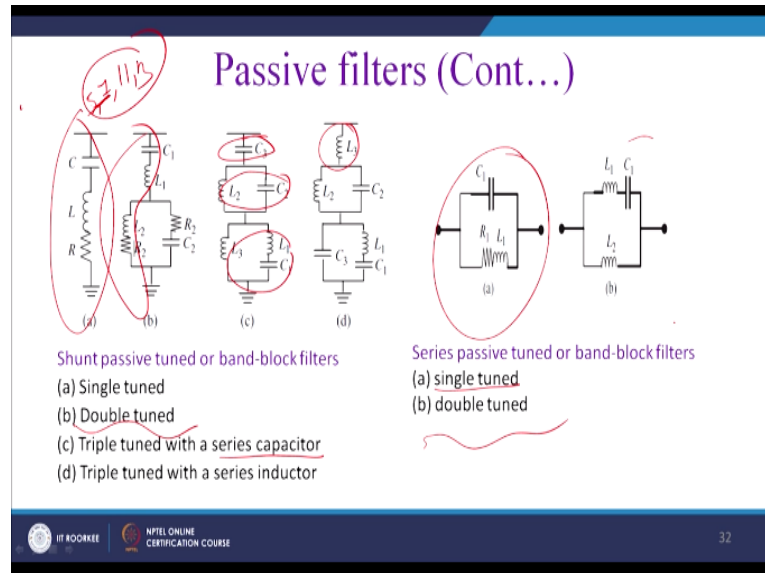

So this is the different kinds of passive filter solutions. So a is a single tuned let us say that when you are actually feeding a highly inductive diode based rectifier and you have a three-phase three-wire system so harmonics will be 5, 7, 11, 13. So you can actually tune this filter with the third harmonics or fifth harmonic or the seventh harmonic. If it is a three-phase four-wire system, then it will be third harmonics.

Otherwise, it will be 5, 7, 11, 13 harmonics and you can actually get rid of a particular harmonics and you can see that fifth and seven are very close. So you can tune some extent at 6 and you can mitigate the fifth and seventh both. Now what about 11, 13 and that made require a double tuned. So these portion of the circuit will essentially give you a one tuning, another portion of the circuit will give you another tuning.

So you can mitigate at least two actually dominating harmonics. So 5, 7 and 11, 13 you can tune some portion this portion of the circuit at 6 and this portion of the circuit may be 12 so thus there you rated 5, 7 and 11, 13 and push it after 19. Similarly, you can have a triplet tune so complexity and the component count will increase so we can see that and this is a triplet tune with the series capacitor.

So first you will have a series capacitor and thereafter this will be tuned to a particular harmonic, this will be tuned to a particular harmonic and this way you can submerge and same way you can have an inductor. So this has a challenge here you know because you know capacitor charging discharging will be an issue. So you know turning on required to be controlled by the thyristor sometime.

So triple tune capacitor will have advantage of the cost but it require controlled mechanism, otherwise capacitors may actually charge or discharge and they give a phenomena of resonance but whereas actually when you have these combinations, inductor tuned so it is quite same but system solution will be bulky. The series passive tuned or the band-block filters, so this is formally the current harmonics separation and shunt voltage separation for the series.

And you know it can be a single tuned that is a and this has a double tuned you can get rid of fifth and seventh harmonic in the current in the voltage maybe and generally these series filters are put into to mitigate the voltage harmonics.

**(Refer Slide Time: 09:56)**

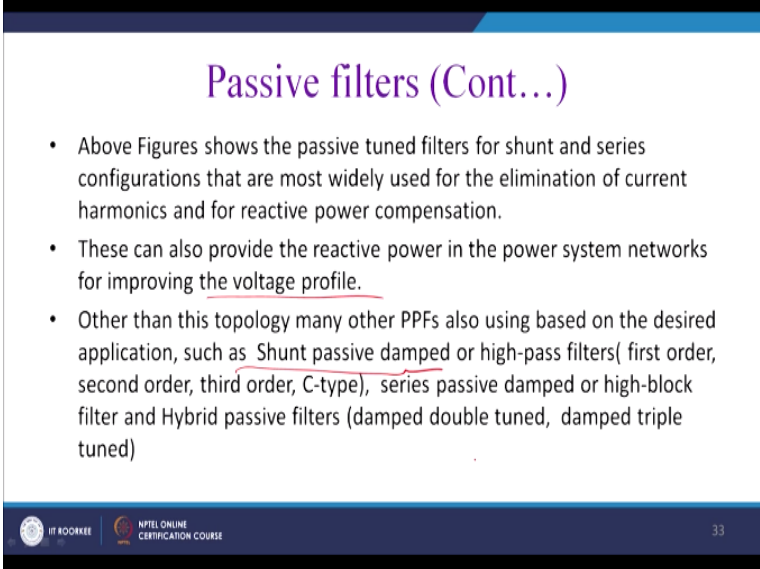

The slide is titled "Passive filters (Cont...)" in purple text. It contains three bullet points:

- Above Figures shows the passive tuned filters for shunt and series configurations that are most widely used for the elimination of current harmonics and for reactive power compensation.
- These can also provide the reactive power in the power system networks for improving the voltage profile.
- Other than this topology many other PPFs also using based on the desired application, such as Shunt passive damped or high-pass filters( first order, second order, third order, C-type), series passive damped or high-block filter and Hybrid passive filters (damped double tuned, damped triple tuned)

At the bottom of the slide, there are logos for IIT Kharagpur and NPTEL ONLINE CERTIFICATION COURSE, and the number 33.

So from this above figure shows that the passive tune filters for the shunt and series configurations that are most widely used for the eliminations of the current harmonics and for reactive power compensation. So we can enhance the actually the power factor. Most of the cases, we feed this load to feed the drive and thus we have a negative wire and for this reason this filter is required to be capacitive in nature.

This can also provide the reactive power in the power system network for improving the voltage profile. Other than this topology many other passive filters are used based on the desired application such as shunt passive damped we require to damped out a particular frequency or the high-pass filter first order, second order or different order; types of the passive damped or high-block filters and hybrid passive filters damped double tuned or damped triple tuned like that can be used.

**(Refer Slide Time: 11:16)**

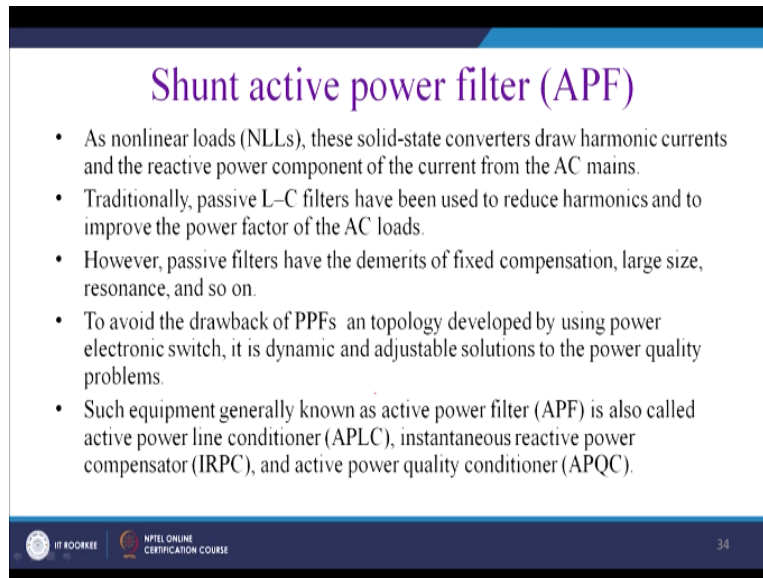

**Shunt active power filter (APF)**

- As nonlinear loads (NLLs), these solid-state converters draw harmonic currents and the reactive power component of the current from the AC mains.
- Traditionally, passive L-C filters have been used to reduce harmonics and to improve the power factor of the AC loads.
- However, passive filters have the demerits of fixed compensation, large size, resonance, and so on.
- To avoid the drawback of PPFs an topology developed by using power electronic switch, it is dynamic and adjustable solutions to the power quality problems.
- Such equipment generally known as active power filter (APF) is also called active power line conditioner (APLC), instantaneous reactive power compensator (IRPC), and active power quality conditioner (APQC).

IT KODAKKE NPTEL ONLINE CERTIFICATION COURSE 34

Now all those filters have three or four disadvantages. First of all, you can see that solution is quite bulky and since the solution is bulky, we cannot and it is associated with the costs and it directs with the time and it affected by the notches and the filters and it is not affected by wire compensation if there is a voltage sag.

So for this reason, we look for a variable situation let us say if your strength of fifth and seventh harmonics has been changed, then your power quality will be sacrificed because you may have tuned to assuming that actually fifth harmonic will dominate the case. So thus we required to investigate for the active solutions. Akagi et al in 1984 proposed basically shunt active power filter.

As nonlinear load this solid-state converter draw harmonic current and the reactive power components of the current from the AC mains. Traditionally, the passive L-C filters have been used to reduce the harmonic and to improve the power factor of the AC loads. However, passive filters have the demerits of fixed compensation, large size and it can actually have a resonance with the power supply and so on.

To avoid the drawbacks of these passive filters, a topology is developed by using the power electronic switches and it is a dynamic and adjustable solutions of the power quality problem. It can inject the harmonic as per the requirement. Such equipment generally known as the active filters and this is called the active filters line conditioners or APLC, instantaneous reactive power compensator or IRPC, active power quality conditioners or APQC. So there are few nomenclatures will be around it with the APF active power filter.

**(Refer Slide Time: 13:53)**

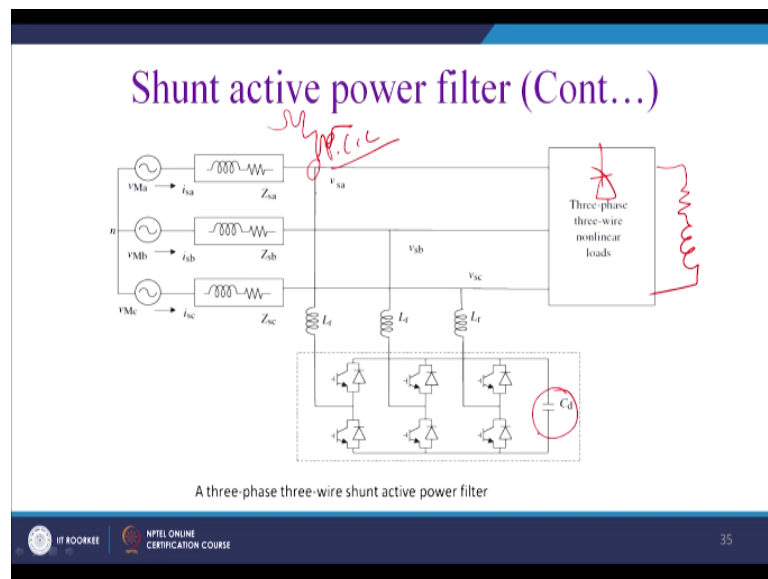

So this is an example of the shunt active power filter, it is feeding let us say highly inductive RL load where you have a diode based rectifier and thus you also have a source impedance and this point is said to be the point of common coupling and you will find without injection current at this point is something like this. This is far from sinusoid. We have seen this waveform in our previous class.

So task of this actually this converter essentially it is a voltage source inverter works in a current control mode and it does not contain any energy storage and it does not contain any bulky capacitor. So task of this capacitor actually to instantaneously balance the voltage, otherwise it does not require anything. So it generates the harmonics and fixes it to the source and so that source will see that as if a balance resistive load is connected at the point of common coupling.

**(Refer Slide Time: 15:08)**



## Shunt active power filter (Cont...)

- The shunt active power filter (SAPF) technology is now a mature technology for providing the reactive power demand by the load, mitigate the current harmonics, mitigate the current unbalance and maintain the DC link voltage as desired value.
- In SAPF the inverter operated as PWM current control or the controller forces inverter to behave as controlled current source.
- Shunt active power filters are also used to regulate the terminal voltage and suppress voltage flicker in three-phase systems.

So the shunt active power filter technology is known as a mature technology for providing the reactive power demand by the load mitigate the current harmonics, mitigate the current unbalanced and maintains the DC link voltage at its desired value. Shunt active power filter inverter is operated as PWM current control or the controller forces the converter to behave as a controlled current source.

It is a voltage source inverter followed it is basically works in a current controlled mode. Shunt active power filters are also used for regulate the terminal voltage and suppress voltage flickers in three-phase system.

**(Refer Slide Time: 15:53)**

## Shunt active power filter (Cont...)

- Shunt active power filters are classified on the basis of converter used such as current source converter (CSC), voltage source converter (VSC), topology used such as half-bridge converters, full-bridge converters, and so on.
- On the basis of supply system, SAPFs are classified into three major categories: single-phase two-wire, three-phase three-wire, and three-phase four-wire SAPFs.
- Many control strategies are reported for SAPF such as instantaneous reactive power theory (IRPT), synchronous frame d-q theory, synchronous detection method, notch filter method, etc.

Shunt active power filters are classified on the basis of the converter such as current source converter. We can use a current source converter also, voltage source converter VSC,

topology such as half-bridge converter, full-bridge converter and so on. On the basis of the supply system, the shunt active power filters are classified into the major categories, single-phase two-wire, single-phase three-wire and three-phase four-wire system.

Many control strategies are reported for SAPF such as instantaneous reactive power theory IRPT, synchronous frame d-q theory, synchronous detection method, notch filter method, etc.

**(Refer Slide Time: 16:44)**

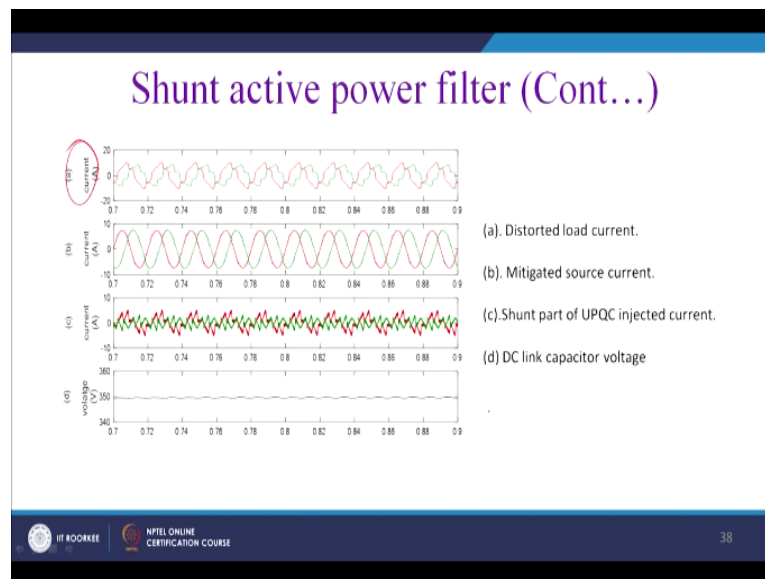

So this is the one of the example of operation of the shunt active power filter. These are the simulation results. So this is basically the current due to and it is unbalanced and two phases of phase A and B are being shown and by injection of the shunt active power filter, voltage as current becomes sinusoidal and also balanced and this is actually the injections of this shunt compensations and this is the DC link voltage of the shunt filter.

**(Refer Slide Time: 17:33)**

## Series active power filter (Cont...)

- The series APF technology is now a mature technology for providing compensation for harmonics present in the voltages and currents in AC networks.
- The series active power filters are mainly used to eliminate voltage harmonics. In addition, they can be used to regulate the terminal voltage, to suppress voltage flicker, and to improve voltage balance.
- Series active power filter inverter working based on PWM voltage control or the control forces inverter to behave as a controlled voltage source

So series APF active power technology is known as a mature technology for providing compensation for harmonics present in the voltage and current in the AC networks. The series active filters are mainly used to eliminate voltage harmonics. In addition, they can be used to regulate terminal voltage to suppress voltage flickers and to improve the voltage balance. This series active filters inverter working based on the PWM voltage control or control current control inverter behaves like a control voltage source.

**(Refer Slide Time: 18:15)**

## Series active power filter (Cont...)

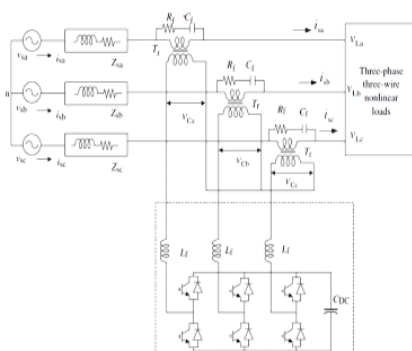

Now let us see the example of the series active power filter, sometimes it is called DVR also. DVR is essentially can mitigate the sag that is a voltage regulator. So if there is a voltage sag essentially, generally what it will do you know it will inject the voltage in phase and thus voltage sag can be mitigated and also this is then we have to supply power from somewhere.

Otherwise if you wish to only to compensate the harmonic part of it, then it can manipulate this harmonic voltage by angle between voltage and current and this can be injected and thus it will actually cancel out the harmonics produced by any harmonic voltage source and ultimately after this point source voltage is being cleaned out from the harmonics. So this solution is basically the series active solutions.

**(Refer Slide Time: 19:27)**

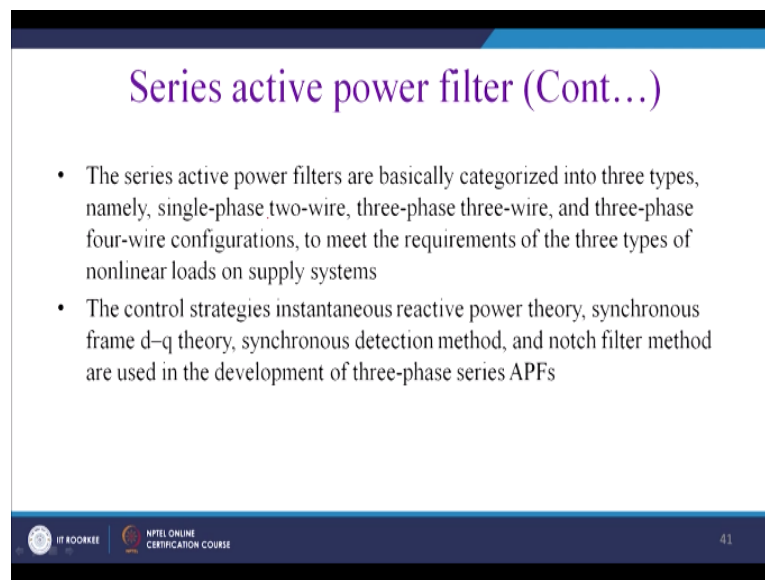

**Series active power filter (Cont...)**

- The series active power filters are basically categorized into three types, namely, single-phase two-wire, three-phase three-wire, and three-phase four-wire configurations, to meet the requirements of the three types of nonlinear loads on supply systems
- The control strategies instantaneous reactive power theory, synchronous frame d-q theory, synchronous detection method, and notch filter method are used in the development of three-phase series APFs

IIT KHARKEE NPTEL ONLINE CERTIFICATION COURSE 41

So the series active filters are basically categorized into the three types. The single-phase two-wire, three-phase three-wire, three-phase four-wire to meet the requirement of different kind of power supply available to us. The control strategies of instantaneous reactive power theory and synchronous frame d-q theory, synchronous detection methods and both notch filter methods are used in the development of this active power filter. Now this is an example of the simulation.

**(Refer Slide Time: 20:14)**

## Series active power filter (Cont...)

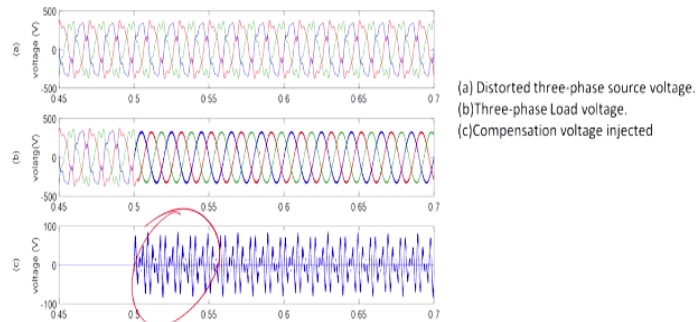

So voltage has been distorted by the notches and this is the injection of the series active filters and after these injections you know voltage line voltage become balanced and sinusoidal.

**(Refer Slide Time: 20:25)**

## Series active power filter (Cont...)

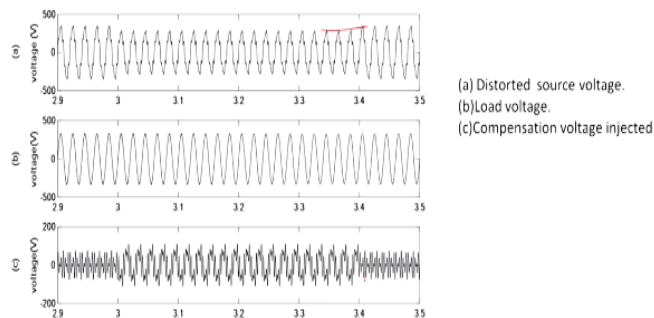

So this is the example of the voltage where we got notches and ultimately this is the line voltage after action of the series filter and this is the voltage injected and you can see that in between there is a voltage solar that also been absorbed by this this active filter.

**(Refer Slide Time: 20:55)**

## Hybrid active power filter (Cont...)

- Active power filters (both series and shunt) have drawbacks that their rating sometimes is very close to the load (up to 80%) in some typical applications
- Thus they become a costly option for power quality improvement.
- Because of higher rating of APFs and cost considerations, the acceptability of the APFs by the users has faced a hindrance in practical situations.
- The rating of active filters is reduced by adding passive filters to form hybrid filters, which reduces the overall cost, and in many instances they provide better compensation than either passive or active filters.

So hybrid active filter, active filters both shunt and series also have a drawback and mainly due to the rating of the switches because switch required to be a very high rating have drawback and their rating and very close to the load up to 80% in some typical applications. Thus, they become costly options and the power quality and the solutions also become costly and customer does not want to take that costly solutions.

Because of the highest rating, active power filters and the costs considerations, the acceptability of the active power filter by the users has faced inertness in the practical situations. The rating of these filters is reduced by adding the passive filter to form hybrid filters and which reduces the overall cost and in many instances they provide better compensation either passive or the active filters.

So you know some part of this will be passive and some part of this will be active. So various topologies are reported as a hybrid filter in shunt, series and the combinations of the both for single-phase two-wire, three-phase four-wire and there-phase three-wire systems using the current.

**(Refer Slide Time: 22:19)**

## Hybrid active power filter (Cont...)

- Various topologies are reported such as hybrid filters in shunt, series, and a combination of both configurations for single-phase two-wire, three-phase three-wire, and three phase four-wire systems by using current source and voltage source converters.

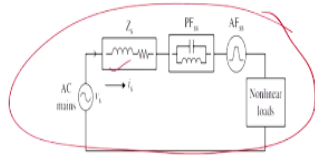

A hybrid filter as a combination of series connected passive series (PFss) and active series (AFss) filters

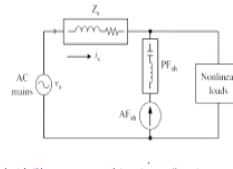

A hybrid filter as a combination of series connected passive shunt (PFsh) and active shunt (AFsh) filters

So this is the portion where hybrid filter is a combination of the series. You know this is the passive filter and thereafter you have an active filter. Similarly, we have passive filters and we have actual shunt active filter and so this combinations are there in case of the hybrid filter. Now let us consider the important aspect of it. We have seen the entities of the voltage connections for the series and the current connection by shunts separately. Now we shall take out both and that is said to be the unified power quality conditioners.

**(Refer Slide Time: 23:00)**

## Unified power quality conditioner

- The unified power quality conditioner (UPQC) is a hybrid connection of shunt and series active power filters and designed for suppression of multiple power quality problems
- UPQC is developed by two voltage source converter connected back to back through a common DC link capacitor and connected to distribution network as a shunt and series format
- Shunt part of the UPQC  
Inject the reactive power demand by the load, mitigate the current harmonics produced by the load, mitigate the current unbalance and maintain the DC link voltage as desired value.
- Series part of the UPQC  
Regulates the voltage quality from power supply side such as voltage harmonics, voltage sag, voltage swell and voltage unbalance

The unified power quality conditioners or UBQC is a hybrid connections of the shunt and series power filter and designed for separation of the multiple power quality problems. UPQC is developed by the two voltage source converter connected back to back through a common DC link capacitor and connected to distribution network as a shunt and series format.

And the shunt part of the UPQC it only mitigate the current harmonics, injects the reactive power demanded by the load, mitigates the current harmonic produced by the load, mitigate the unbalanced and maintain the DC link voltage as desired value and whereas a series does the same thing for its voltage counterpart. So it regulates the voltage quality from the power supply such as voltage harmonic, voltage sag, voltage swell, voltage unbalanced.

**(Refer Slide Time: 23:58)**

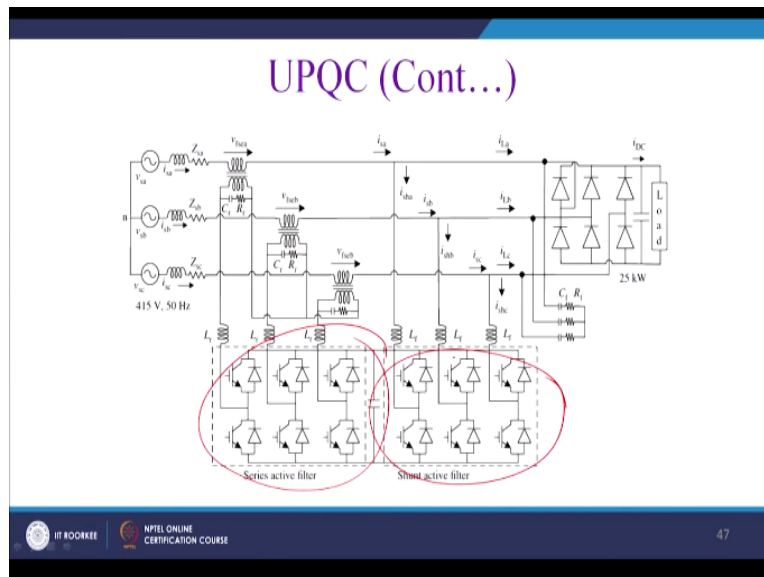

So this is the overall figure of the UPQC. Here this part is series that will be actually responsible to compensate the shunt portion actually voltage part of it and it will mitigate all the issues related to the voltage sag, voltage swell, voltage harmonics and this part is the shunt part and this is for this is the high-pass filter to mitigate the switching of these filters and you may have actually disturbed voltage source.

And this will be rectified by this actually series part of the filter, then thus at this point voltage clean term but due to this actually nonlinear load current get actually distorted and that required to be corrected or fix it up by this actually the shunt active power filter. So these two combinations you know gives us total power quality solutions for three-phase three-wire system and there are different kind of shunt topology.

Students are requested to refer my facts classes that are available in YouTube. There different kind of topologies has been discussed for UPQC, for shortage of time; we have to actually curtail our discussions here. So these are the few aspects of it. Now these are few things we have to keep in mind, for these are just we have just touched upon this power quality issues



briefly and main challenge are this active power filters are to rightly estimate the reference current that is required to be injected by this voltage source inverter either series or shunt.

So this is one challenge and for there is a different kind of reference generation technique, these techniques are may be time domain and may be the frequency domain. In a time domain, we have a decubitus technique; we have a unified IPRF power quality rectifier solutions by Akagi. You may have a synchronous mode solution and also you have a different solutions in the frequency domain.

That is FFT, DFT, FFT and otherwise you can actually apply soft computing technique. Next, part comes basically tracking, this actually current reference that is a control problem and we choose a different topologies here so researcher can work in a different topology part of this UPQC and while it will inject the current and how we will see that with the reduced switches.

So you have instead of that actually here for the two-level inverter, we have here essentially 12 switches and can we actually reduce the switches this topology. This is also a challenge because as you have seen that cost is a major factor to accept among the customer. So this area research is still going on and apart from that we required to see that how essentially this rating maybe actually 6.6 KVA and this rating can be maximum suitable for the range of anyhow in thousands of volt.

So we require a transformer and this transformer essentially bulky, so where actually can we replace a different kind of transformer that the solid-state transformer we have discussed. So in that way, we can give a total power electronic solution to the power system problem of power quality. Thank you for your attentions. We shall continue to our next class with control aspect of the power electronics. Thank you.