

Energy Conservation and Waste Heat Recovery
Prof. Prasanta Kumar Das
Department of Mechanical Engineering
Indian Institute of Technology, Kharagpur

Lecture – 36
Heat Exchanger Network (HEN) (Contd.)

So welcome back, we were discussing regarding heat exchanger network analysis, we are halfway through. We have taken an example from the reference I have given from the paper of Lenaf and Hindmarsh, and the example discussed in the same paper we have picked up, and so far what we have achieved, if we go little bit back.

(Refer Slide Time: 00:50)

Subnetwork	Streams and Temperature			Deficit	Accumulated		Heat Flows	
	Cold Streams	T°C	Hot Streams		Input	Output	Input	Output
		150						
SN1	3	125 145	(2)	0-10= (-10)	0	2*5=10	HU 107.5	117.5
SN2	(2.5)	4 100 120		10- (-2.5)=12.5	10	10+25*2- 25*2.5= -2.5	117.5	105
SN3	(3)	70 90		105	-2.5	-2.5+30*2- 30*2.5- 30*3= -107.5	105	0
SN4		40 60	(8)	-135	-107.5	27.5	0	135
SN5		25	1 2	82.5	27.5	-55	135	52.5
SN6		20		12.5	-55	-67.5	52.5	CU 40

So, this is the problem table by tabular solution, we have find out the hot utility requirement, cold utility requirement and the pinch point. So, this is what we have identified. And then what we have done.

(Refer Slide Time: 01:03)

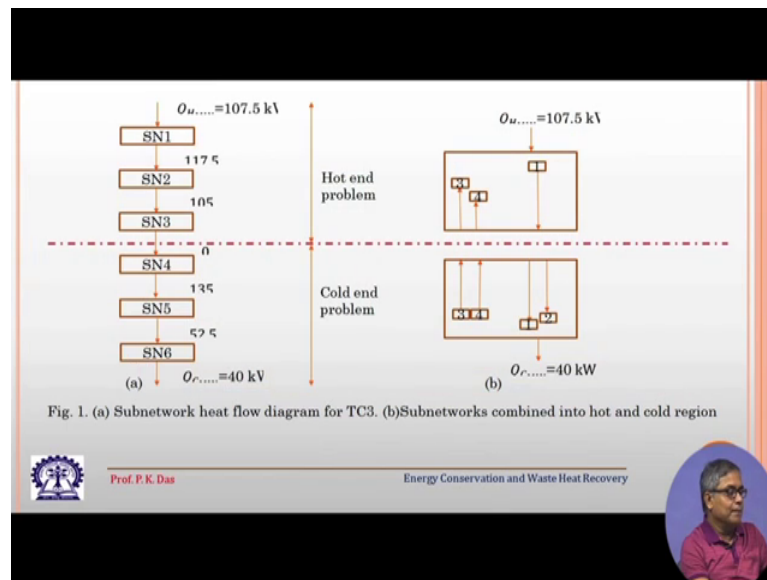



We have told, that once we have the pinch point, the problem can be divided into hot end and cold end, and the sub network, how the energy is flowing, from the highest temperature to the lowest temperature it is shown. It has to be remember that highest temperature is the temperature of the hot utility available. Lowest temperature is the temperature of the cold utility available, and this is how the energy flow takes place.

Now, with that we will have this is our hot end problem. So, hot end problem from the hot utility this much amount of heat has to go. At the pinch point there is no heat transfer, this is the cold end problem. In the cold end problem this much amount of heat has to be dumped to the cold utility.

(Refer Slide Time: 01:56)

Rules for PINCH ANALYSIS

1. Pinch point divides the HEN into two independent problems to be solved separately.
2. No heat flow is allowed across pinch point.
3. No cold utility to be used in the hot end.
4. No hot utility to be used in the cold end.
5. Violation of (2) – (4) gives double penalty
6. Design of each end should start at the pinch point.

 Prof. P. K. Das Energy Conservation and Waste Heat Recovery 

Now, with this, we have given certain rule. These rules are simple rules.



(Refer Slide Time: 02:08)

Rules for Pinch End Matching

1. For hot end $N_H \leq N_C$ N_H · No of Hot stream
For cold end $N_C \leq N_H$ N_C · No. of cold stream

Note: In the hot end, there is some amount of hot utility & hot stream which can only exchange heat with cold stream.

2. For individual match
Hot end, $C_H \leq C_c$
Cold end, $C_c \leq C_H$
3. For hot end
$$\left(\sum_1^{N_c} C_c \cdot \sum_1^{N_H} C_H\right) \geq \sum_1^{\text{No. of Matches}} (C_c - C_H)$$

 Prof. P. K. Das Energy Conservation and Waste Heat Recovery 

But they are very important, and they are based on laws of thermodynamics. With this I can take some example.

(Refer Slide Time: 02:11)

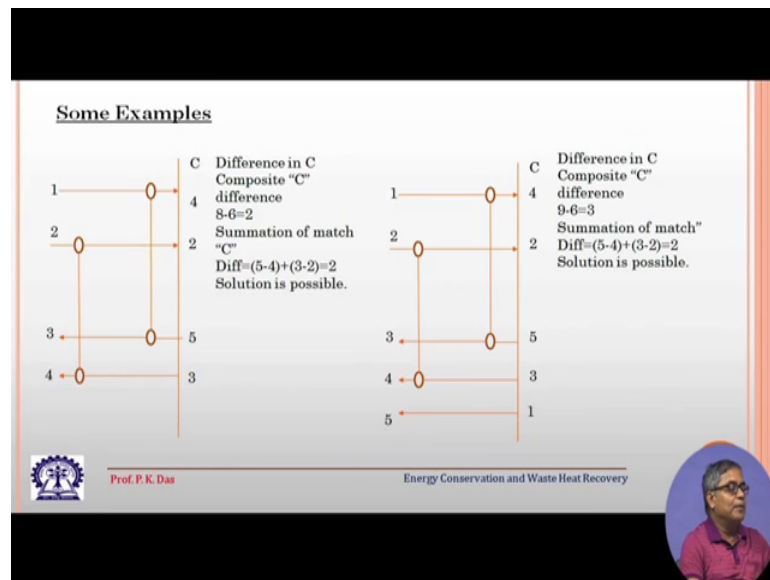

Let us say, these 2 are the 2 streams, and these are also, these are 1 2, these are 2 streams, and these are 2 different streams. So, four streams are there. So, difference in C. First thing is, or composite C difference. So, it will be 8 minus 6 that is 2; say this 1, 2, 3, 4 are the stream numbers, and here 4, 2, 5, 3, etcetera, these are the heat capacity rate.

So, difference in composite C what it will be. The composite C in this side it is 8, and in this side it is 4. So, 8 minus 6 that is 2, summation of match; that is what we have got, summation of match C. suppose this kind of match we have got, that match we have proposed; that means, there is stream 1 and stream 3. We are thinking of one heat exchanger between them. So, this is the symbol why which we will show a match, this shows a particular heat exchanger.

Similarly, we are thinking another heat exchanger between stream 2 and stream 4. So, this is another heat exchanger. So, in this case what is the difference? In this case difference is 5 minus 4; that is the individual match difference, and in this case the difference is 3 minus 2. So, in this case this is 5 minus 4 is equal to 1, and 3 minus 2 is equal to 1. So, this is 2. So, solution is possible, because we are considering the hot end of the problem.

And here you see another kind of a example we have given, that here there are 3 streams, and here there are 2 streams; so, difference in composite C, composite heat capacity rate. So, 5 plus 3 plus 1; that is your 9 and 4 plus 2 that is 9 minus 6 that is 3, and summation

of match, so we are considering one match between 4 and 5; that means, stream 1 and stream 3. And another match we are considering between stream 2 and stream 4.

So, in this case difference is, 5 minus 4, and in this case the difference is 3 minus 2. So, this will be 1 plus 1; that is 2, here also solution is possible. So, this is how we have to check, whether we are obeying the pinch rules, or rules at the pinch point, because as I have told our design should start from the pinch point. Why the design should start from the pinch point, because the condition at the pinch point is this more stringent. At the pinch point we are having, minimum amount of temperature difference allowable between the 2 streams.

So, if we violate this thing, then our design is not according to this specification. So, we have to be very careful like this. In at other places we will find that the temperature difference between the 2 streams are more than 20 degree Celsius or pinch point, but here it is the minimum, so we have to be very careful. We have to start the solution from the pinch point, and either we have to move towards the hot end or highest temperature end, or we have to move towards the lowest temperature end.

(Refer Slide Time: 06:17)

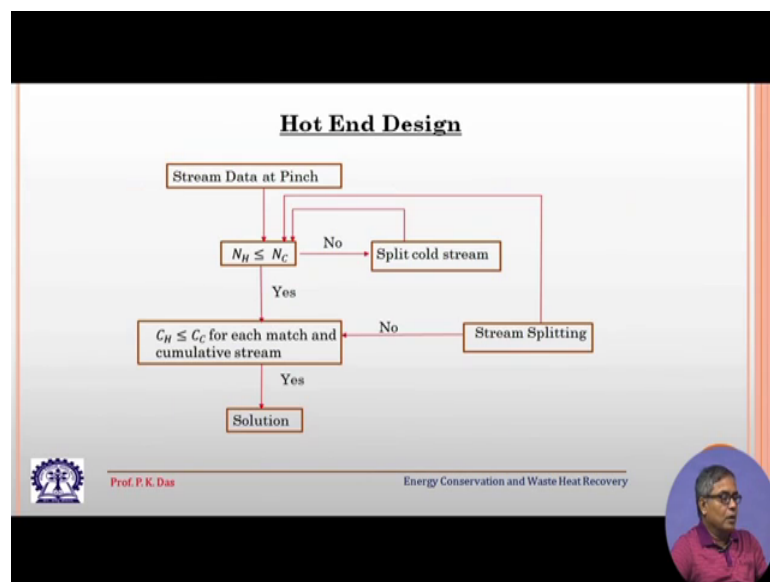

So, this is kind of a logic diagram for hot end design. I do not think much explanation is needed, whatever explanation is needed, I have put it in some sort of a flowchart that this has to be satisfied. This is almost self explanatory, and this has to be satisfied. First we have to check the number of streams hot stream and cold stream. So, number of hot

stream should be less than the number of cold streams, and if we satisfy, then we have to satisfy for each match. If that does not match, then we have to go for stream splitting. Suppose the number of hot stream, is not less than number of cold stream, then what we have to do. We have to split one cold stream into 2 cold stream. So, now, the number of cold stream will increase.

(Refer Slide Time: 07:17)

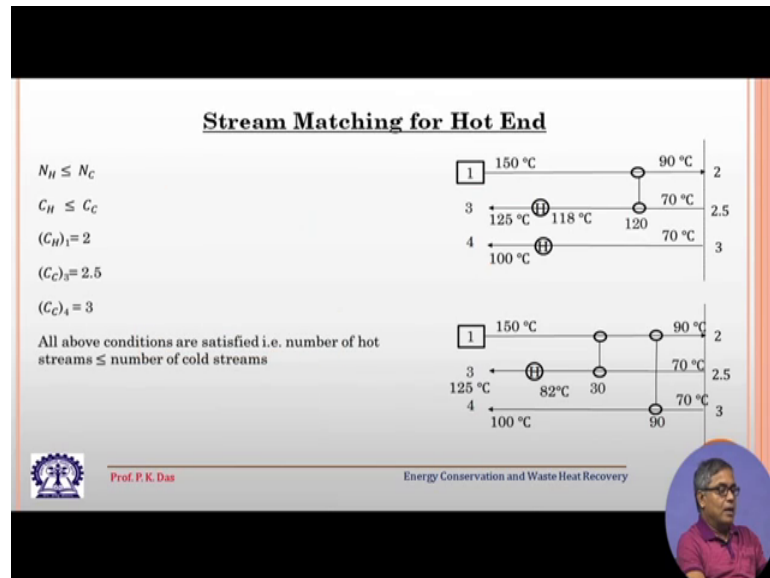

So, this we will explain as we proceed with the example. So, this is the hot end. So, hot end, there are, for the present problem of hot end there are 2 streams 3 streams. So, one stream start from 150 degree Celsius, it goes up to your 90 degree Celsius. Another cold stream, the pinch point for the cold side is 70 degree. So, from 70 degree to 125 degree Celsius, and another one is from 70 degree to 100 degree Celsius. These are not the supply temperature of the cold stream.

So, what we can think of. We can think of a match between stream 1 and stream 3. So, this kind of a match we can think of, and 120 will be the amount of heat exchange in this heat exchanger. So, by that we will be able to get the pinch temperature of the pinch temperature for the hot stream, and then we have not to bother regarding the hot stream, because in this end the hot stream is to be cooled from 150 degree Celsius to 90 degree Celsius only.

So, we can tick off the hot stream. So, this is called tick off method. For other 2 cold streams, the remaining 2 streams which are cold streams. For them we do not have any

hot stream to exchange heat. So, we have to use heat utility here, or other hot utility here. So, we can find out what amount of hot utility has to be used, and we can solve this problem.

The other thing is that, this is not the only solution. We can think of another solution, where at the pinch end just adjacent to the pinch end, pinch point. We can think of one heat exchanger between 1 and 4, and the amount of heat exchange is, 90 unit. Then we can think another heat exchanger between 1 and 3, the amount of heat exchange is 30. So, by this we have satisfied the top stream; that means, the hot stream we can tick off it. We have satisfied the requirement of the stream number 4, this is the cold stream, we can tick off this, but the stream number 3 needs further cooling, further heating.

So, one hot utility has to be used, and we can calculate how much hot utility is needed. And you will find whatever hot utility we have used by 2 heaters here or 2 heat exchangers here, same amount of hot utility has to be used, because this is the minimum amount of hot utility. So, you see here, we get one heat exchanger, second heat exchanger, third heat exchanger. Here also we get one heat exchanger, then second heat exchanger, third heat exchanger. So, 3 heat exchanger in both the cases we get. We get same amount of hot utility to be used, but the advantage is that, that we are getting 2 solutions. So, 2 options are available to the designer or design engineer, and depending on plant requirement one can take any one of these options.

(Refer Slide Time: 11:06)

Stream Matching for Cold End

$N_C \leq N_H$	
Cumulative, $C_C \leq C_H$	
8	3
2	2.5

So, we have to split hot stream

Prof. P. K. Das

Energy Conservation and Waste Heat Recovery

Now, if we go for stream matching for cold stream. So, what we find NC is less than equal to NH. So, that is one good thing we have found. So, this is satisfied, but for cumulative CC and CH, this is 8 and this is 2. These are the 2 streams and the other side we have got 3 and 2.5. So, 2 and 2.5 matches 2 is less than 2.5, but 8 and 3, they does not match, they do not match. So, this is not possible. Then can we match with 8 and 2.5, 3 and 2. You see this side is the hot side; this side is the cold side.

So, this match is not acceptable. This match is acceptable 8 is higher than 2.5, so this match is acceptable, but this match is not acceptable. So, this match is not acceptable and this match is not acceptable.

(Refer Slide Time: 12:24)

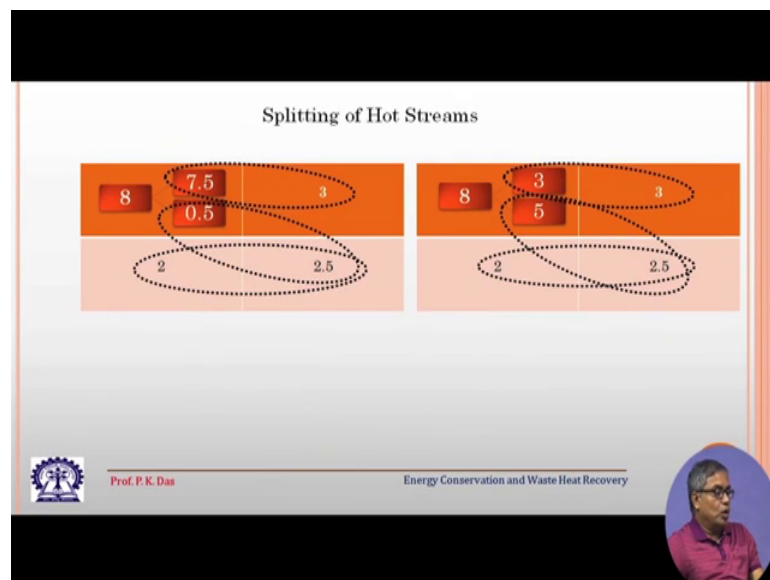

So, without stream splitting we cannot have any answer in this case. So, now, we go for stream splitting. Stream splitting also can be of different kind of stream splitting we can go for. What we can do, that 8 is having highest heat capacity rate. So, let us think of splitting this stream. So, we can have 2 streams 7.5 and 0.5 and 3.

So, this is workable. Again this is workable, and the third is also one workable, or this stream with heat capacity rate 8, we can divide it into 3 and 5. So, there we are getting 3 matching. All 3 are workable, because you see the 3 and 3; that is workable, and 5 and 2.5 that is also workable. So, with this let us go to the next level. So, next level for the cold end, we get the solution like this, from the. So, there is a stream splitting needed.

(Refer Slide Time: 13:27)

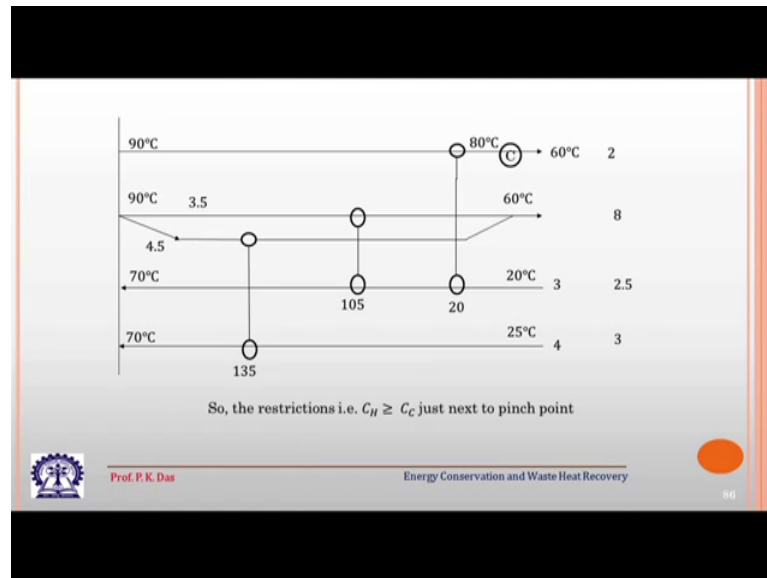

And we have already shown the stream, which is having 8 heat capacity rate, the hot stream that has to be split into two. So, here we are showing this stream has been split into two. Now you see we are starting from the pinch point, and one heat exchanger we propose like this. And how we have split the heat capacity rate; one is 3.5, another is 4.5, these are the heat capacity rate.

So, one heat exchanger we can consider like this. The next heat exchanger we can consider like this, and first heat exchanger after the pinch point we do; that means, these streams condition is matched, and we can tick off this one. Then we can think of the second stream, second heat exchanger. So, this heat exchanger if we consider, then this stream which has to reach 60 degree Celsius, it can be brought to 60 degree Celsius we can tick off this. For the third we can consider a match between stream two, between this stream; that means, this is another heat exchanger we can consider, and with this the this stream, third stream that can be satisfied.

So, if we do that, only the topmost stream which has to be cooled. So, that is left, and here we have to use one cold utility. How much cold utility we have to use. You can calculate and you will see whatever solution we have got. So, with that cold utility we will be able to satisfy this situation. So, this gives the solution of the cold end of the problem.

So, with this we will be able to design the cold end. Other possibilities are there, we can have an alternative design of the cold end. So, we have got some alternative design of the hot end, if you see that we have got 2 alternative designs of the hot end, and we have got one design of the cold end; of course, we can get alternative design also, and then we have got several alternatives, and then we can stitch. One possible hot end design can be stitched with one possible cold end design.

So, then it will give the total design of the heat exchanger network, and our heat exchanger network synthesis is done. What we have got? We have got the minimum amount of cold utility to be used; we have got the minimum amount of hot utility to be used. We have got the stream matching, that which stream has to be matched with which other stream. We have got also the number of heat exchangers to be used, number of stream heat exchanger to be used, number of heat exchanger between streams, and number of utility heat exchangers to be used. So, all we have got, and that brings us to the complete solution of the heat exchanger network. I think it would be good for you, the reference is given.

So, you can go to the reference. See the problem once again; obviously, the reference gives much more discussion, and some more insight. So, I would strongly suggest that one should go to the reference. The problem one can understand from whatever has been presented here, but more background material can be obtained from the reference. So, I strongly suggest to go to the reference. With this I come to an end of this particular lecture, and now onward my colleague Professor Anandaroop Bhattacharya will take up, and other topics of waste heat recovery and energy conservation will be dealt by Professor Anandaroop Bhattacharya.

So, thank you, thanks to all of you.