

Metrology
Prof. Dr. Kanakuppi Sadashivappa
Department of Industrial and Production Engineering
Bapuji Institute of Engineering and Technology-Davangere

Module-2
Lecture-2
Combination set, Vernier calipers

(Refer Slide Time: 00:16)

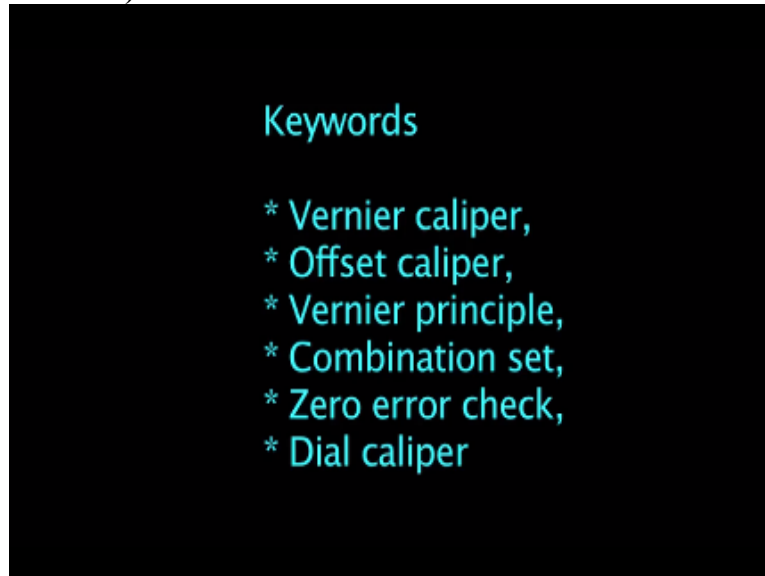

I welcome you all for today's lecture that is module 2 and lecture 2. In this lecture we will be discussing about the combination set, the vernier caliper.

(Refer Slide Time: 00:34)

Linear measuring instruments

1. Combination set
 - Construction and uses
2. Vernier caliper
 - Construction and uses
 - Variants

The combination set is mostly used by machinists in the workshop for various purposes. So we will study the construction part of the combination set and what are the various uses of combination set. Then we will move to vernier caliper and we will learn the construction and

various parts of a Vernier caliper and then how to use a Vernier caliper for inside diameter measurement and then ID measurement and OD measurement outside the dimension measurement.

And then we will see what are the various types of vernier caliper available, then we will move to height gauge, we will study the construction of the height gauge and the various applications of height gauge and then what are the various types available that also we will study. Now first let us study about study the combination set.

(Refer Slide Time: 01:42)

Combination set (steel rule, square head, protractor head, center head and a scriber)

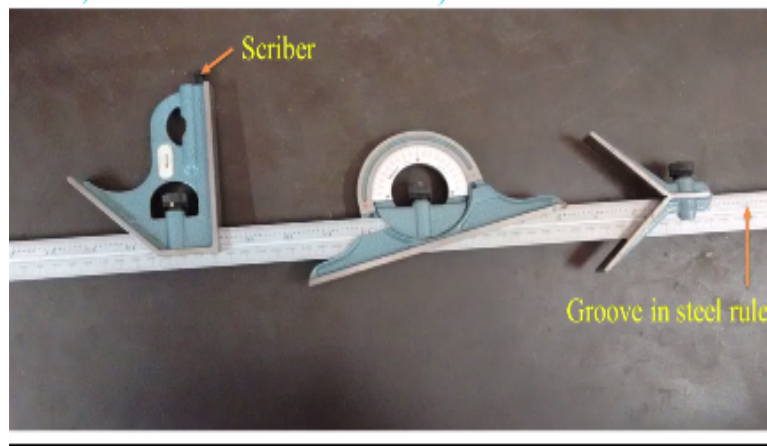

Now the figure shows a combination set wherein we have this steel rule and we can observe that at the centre we have a groove, I can see that were both edges, on both edges we have the scale, one side it is in the system under the other side it is in the metric system and 3 units are mounted on the steel rule for this is called centre head, you can see that the screw for clamping this centre head to the steel rule.

And then we have protractor head so I can see the protractor fix to the head and again at the centre the screw to for the clamping purpose we can always rotate this part and we have to insert the work piece between the steel rule and this surface. So that we can directly get the angles and then the third party is square head, this is used to check squareness of the work pieces and an angle of 45 degree.

And then spirit level is also provided for checking the levelling of surfaces and then there is a scribing which can be used for scribing lines on the work piece and again screw for clamping purpose.

(Refer Slide Time: 03:24)

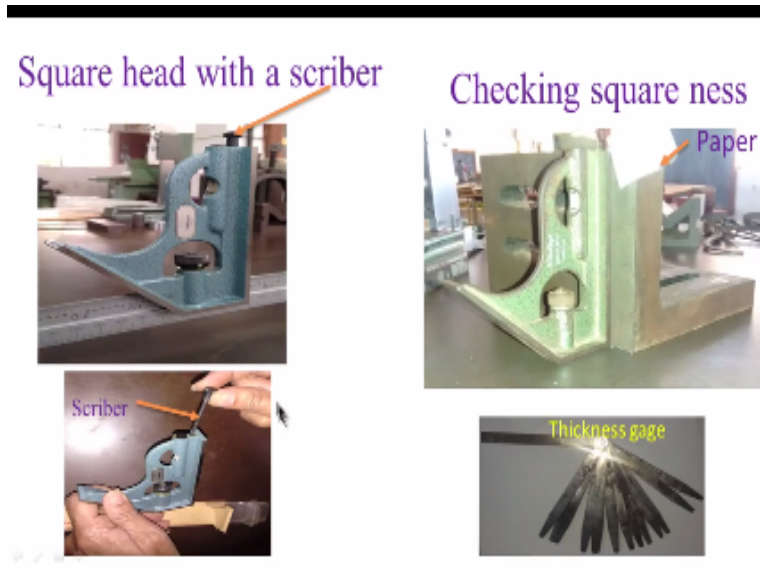

Now let us start how to use a square head. Now here we can clearly see the groove provided on the steel rule for guiding the square head and then we can see the checking of a work piece, now this is the work piece for which we need to check the squareness, that is whether this surface is perpendicular to the bottom surface that we need to check for that we can use the square head as shown here.

Now we have to put the vertical surface of the square head with this vertical surfaces and then we should try to insert paper, if it enters it indicates that there is some error in a square if it does not enter then it indicates that their squares is ok. So if you want any gap measurement then we can instead of paper we can always use thickness gauge which has various leaves of different thickness.

So by selecting the proper leaf and if we try to insert that leaf if it enters then a dimension is mentioned on that particular leaf. So if 0.01 mm leaf enter here that indicates that the error at this over this height is 0.01 mm. And then this shows the square head with a scribe and there is a space provided for inserting scribe.

(Refer Slide Time: 05:17)

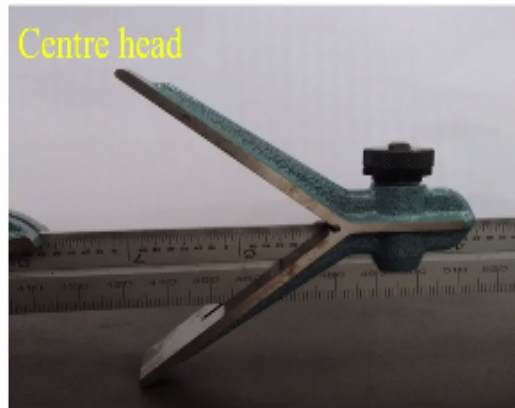

Now we will see the centre head this is a steel rule with the groove and can see and then this side we have English graduations and here we have metric graduations. Now this centre had you can see the angle between the two surfaces is 90 degree, so with respect to this late at this angle will be 45 degree and again this angle will be 45 degree. We can see that there is a groove provided in the centre head for inserting steel rule.

(Refer Slide Time: 06:06)

Finding center of cylinder

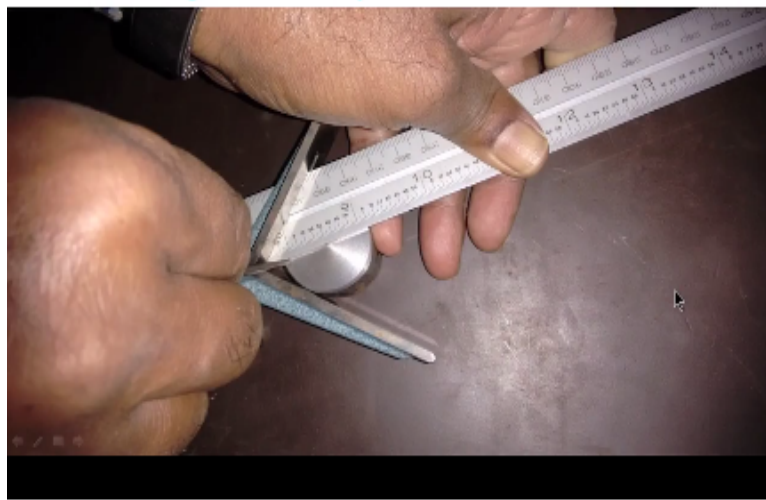

Now how to use the centre head this is used to find centres of cylindrical objects so we have a cylindrical objects here and we have to place the two legs of the centre head as shown here, one leg should touch the work piece here and the other leg will be touching other side of the work piece which we cannot see here and now we have to take describe it provided in the combination set and then we have to scribe a line by taking the edge of the steel rule.

As reference we can always draw a line and then we have to rotate the work piece and again we have to draw one more that scribe one more line. So intersection of those two lines will give the centre point of the work piece.

(Refer Slide Time: 07:10)

Centre of round work piece

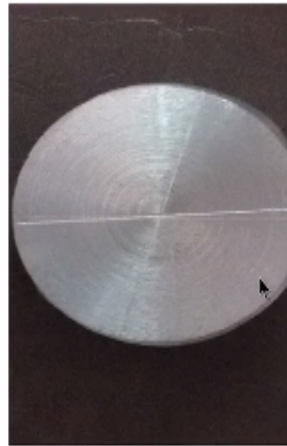

So that we can see here we have a line scribed on the work piece office and we have another line scribed on the top surface of the work piece, the intersection gives the centre of the round work piece.

(Refer Slide Time: 07:30)

Square head with steel rule used as a height gauge

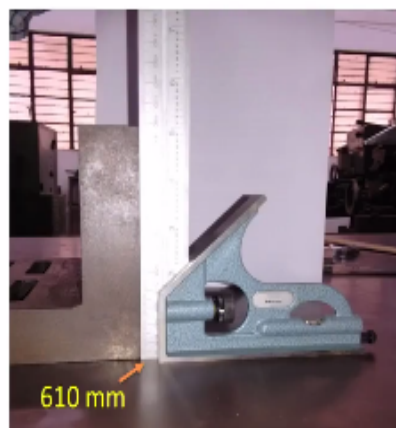

Now let us study how to use square head with steel rule to measure the height of the work pieces. Now I can see the square head is placed as shown here and the steel rule is a vertical, now this reading at this age the reading of the steel rule is 610 millimetre. So this becomes

their reference. And then we have to read the steel rule and we should not down what is the reading here so this becomes measurement point.

(Refer Slide Time: 08:20)

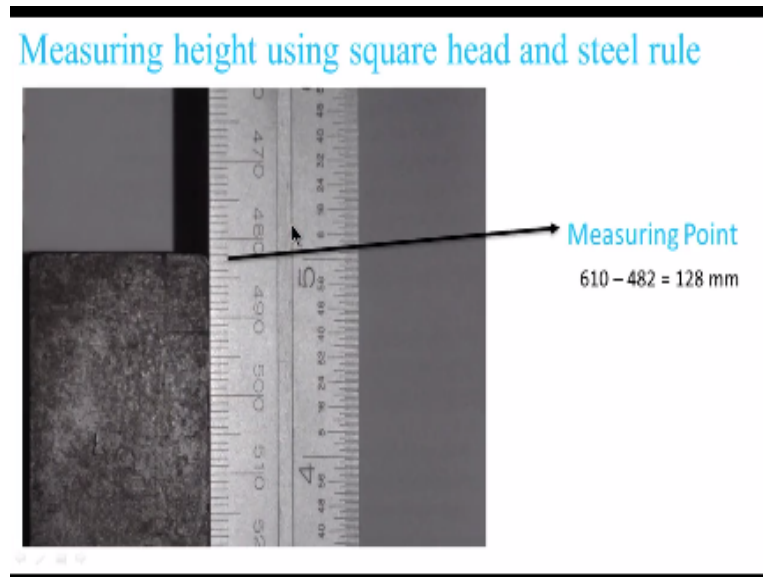

The difference between this reading and the reference point reading gives the height of the work piece. Now you can see the reading at the top the top surface area but rate from the top 470, 475, 480, 481, 482 millimetre. So the difference is $610 - 482 = 128$ millimetre. That means the work piece height is 128 millimetre. So the resolution available in this steel rule is 1 millimetre. So we get reading in terms of millimetres up to a resolution of 1 millimetre.

(Refer Slide Time: 09:06)

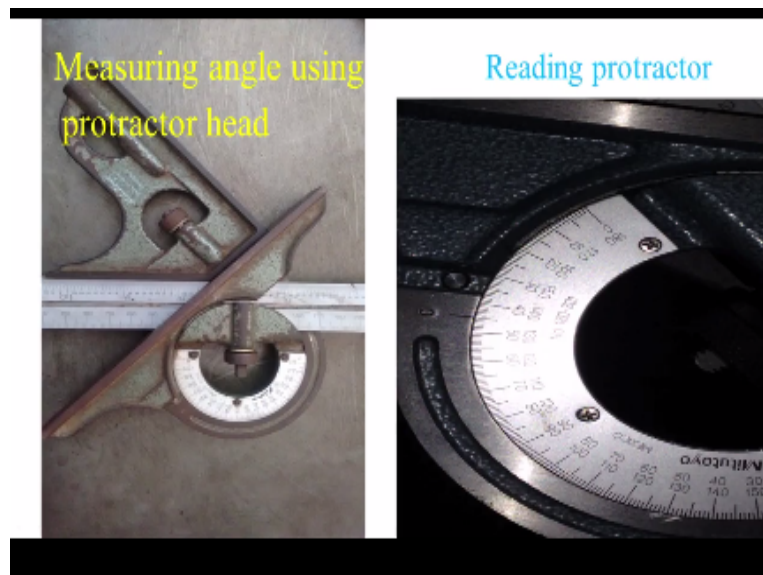

Now let us study the measurement of angle using protractor head. Now I am trying to measure the angle between this surface and this surface of the square head ok. Now I can see one surface of a square head is in contact with the steel rule and other surface is in contact

with the protractor head surface like this. Now you can directly read the angle between this head and this thread angle so that we can directly get without any calculation using this protractor.

So the reading how to read the protractor I have shown here I can see here is the 0 degree, 10 degree, 20, 30, 40, 45, this is a reference line. So this angle is 45 degree, so $180 - 45$ gives the angle, that is 180, 170, 160, 150, 140, 135 degree, so 135 degree angle between this edge and this edge.

(Refer Slide Time: 10:46)

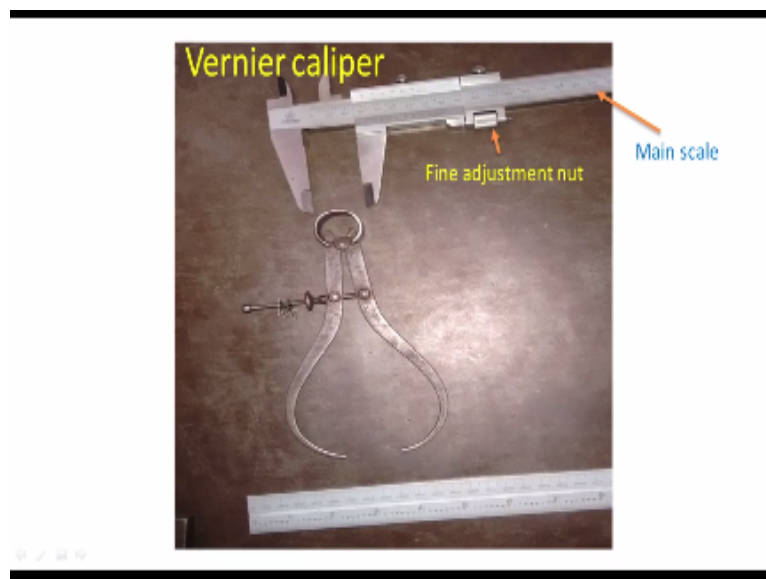

Now let us start the discussion on Vernier Caliper. Now you can see here we have a steel rule and we have outside caliper. So outside caliper does not have its own graduated scale, so we always used outside caliper along with their steel rule. So one leg will be a reference the reference point and another leg give the measurement point. And then we have to transfer this distance over the steel rule to get dimension of the work piece.

Now this is this vernier caliper is a combination of these two designs, we have 2 measuring jaws ok. So one corresponding to this like the other one corresponding to this like.

(Refer Slide Time: 11:43)

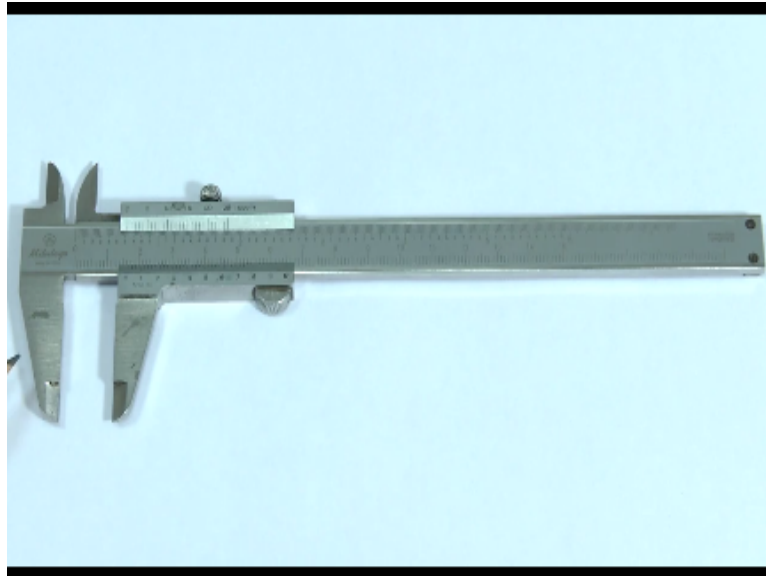

Now let me show a Vernier caliper, now this is the main part of the Vernier caliper, this is called beam on the way we can see on the lower side we have graduations in the metric system and upper side of the beam we have graduation in English system, to the beam as jaw is fixed, so this is called fixed jaw and this portion is measuring head, measuring head accommodates vernier scales.

So this side vernier is in inches system and here vernier is in the metric system. Now to the measuring head the jaw is fixed, so when we move the moving earring head along with that this moving jaw will also move are these are the measuring the surfaces, so this is the measuring the surface of the moving jaw and this side we have the measuring surface of the jaw, now this is provided so that we can put everything here and then we can move the measuring head.

At any desired location we can climb the measuring head with the beam by tighten this screw, so these two jaws are used for measuring outside dimensions and these two jaws are used for measuring inside dimensions, trading surfaces of a vernier we can see here this is one guiding surface design guiding surface on the ground find the ground like this measuring head will move.

Now before using the Vernier caliper it is very important to check that whether there is any clearance between the beam and the measuring head. Now if there is any clearance if there is any movement if there is any clearance between the measuring head and they beam we can

see here a wear block is provided inside, so we have to operate these two screws and then that slackness can be eliminated and then we can use measuring instrument.

Now you can see the measuring surface, it is very important that this measuring surface and the other measuring surface should have the proper flatness, their finally ground and left to maintain very good accuracy of flatness. The flatness of a micrometre than that is mentally and another very important thing is this measuring surface and this measuring surface should be parallel to each other.

And parallelism of 1 micron or lesser than that is maintained, now we can see the main scale and vernier scale clearly the main scale is having a resolution of 1 millimetre, now when we take the reading for example I want a distance between this surface and surface now you can read we have to read the main scale main scale reading is 10 mm, 11 mm, 12, 13, 14, 15. Now you can see 0 this reference line is crashing fifteenth graduation.

That means 0 it lie on the vernier has crossed 15,15 division, so main scale reading is 15 m, and then we should look for the coinciding division. Now we can see that the graduation mark 9 is coinciding with the graduation marks 6 in the main scale. That means this graduation 9 means 9×9 totally 45 graduation are their up to 9. So 45 into the resolution that means $0.02 \text{ millimetre} = 0.9 \text{ mm}$.

So this 0.9 mm we have to add to the main scale, so main scale reading is 50 mm and Vernier reading is 0.9 mm, so total is 15.9 millimetre. So that is the distance between the two measuring surface. So this is how we should take readings.

(Refer Slide Time: 16:53)

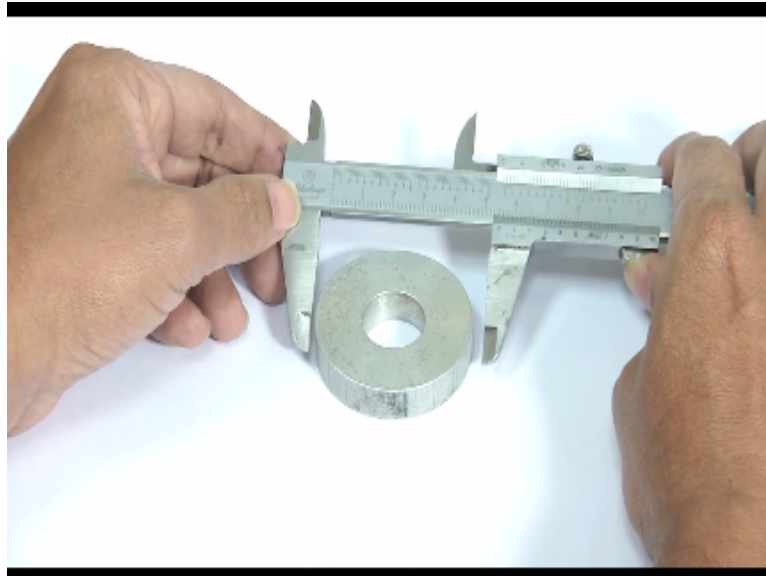

Now let me show how an external dimensions can be measured using Vernier caliper, have taken round the outside diameter of which I have to measure. So we have to hold the work piece between the two jaws and then they have to slowly move the jaws closer to the work piece. We should never use the ends of the jaw we should always try to use the centre portion of the jaws.

Now I am moving the jaw ok, now they moving jaw has come in contact with a work piece, now I can clamp the measuring head to remove the Vernier caliper from the work piece, now I can read the scale, now we can see how the 0 lying here, it is just crossing the fifth graduation on the main scale. That mean this from 0 to 5 it is 50 mm, that means 50 mm is the main scale reading.

Now I have to look for the coinciding division we can see that this graduation mark with 4 is coinciding with the graduation mark 7 on the main scale. That mean from 0 to 4, 20 divisions are there, so resolution of this is 0.02×20 division that is 0.4 millimeter. So we have to add. 4 min to the main scale reading then we get the outside diameter of a work piece. That means is $50 + 0.4 = 50.4$ mm is the outside diameter of the work piece.

(Refer Slide Time: 19:42)

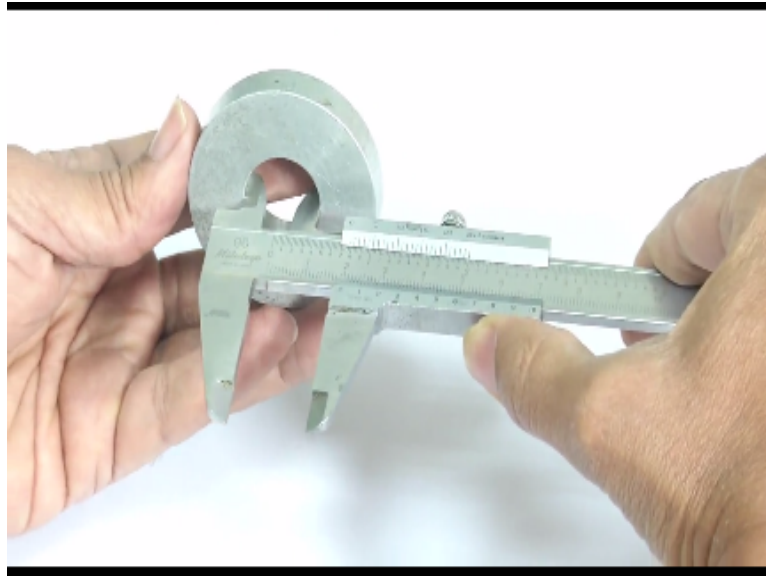

Now let me show how the inside diameter can be measured using the Vernier caliper, we have to use the jaws meant for inside measurement now I am inserting the work piece over the jaws, and we have to take care that 2 jaws meet the work piece of the diameter not at any other call. Now you can take the reading, the reference line that is zero outline of a vernier is coinciding with graduation mark 2 on the main scale.

(Refer Slide Time: 20:36)

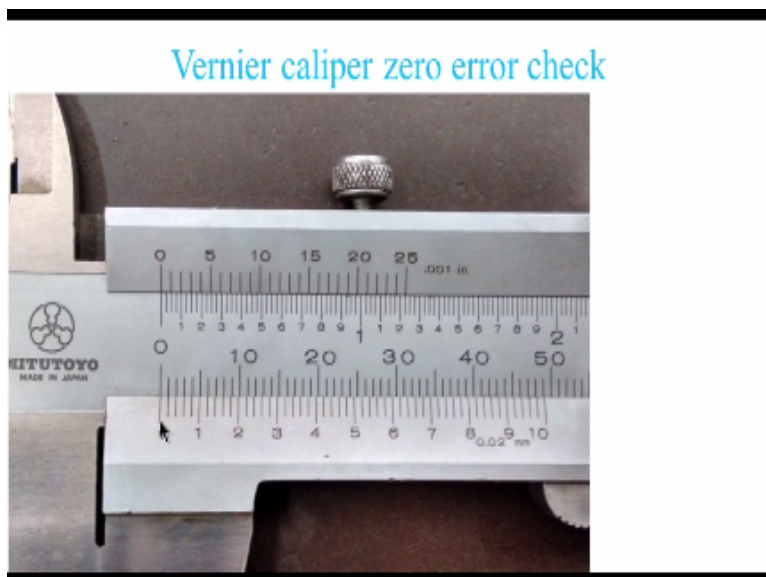

So the inside diameter of a work piece is equal to 20 millimetre now you can see here they both the jaws are in contact and we have 0 on the vernier, it is coinciding with 0 on the main scale, so when this happened it indicates that there is no 0 error in the instrument and now we can observe the main scale. So main scale graduations we can clearly see this is the range of this instrument is 0 to 150 millimeter with the resolution of the main scale is 1 millimetre.

Now we have to get more accuracy vernier principle is used in this instrument, now we can observe that 0 to 49th reading of the main scale is taken and that is divided into 50 graduation that mean the resolution of this instrument is 1 upon 50 minute that is equal to 0.02 millimeter. That mean is graduation the distance between these two any two graduation on the vernier represents a moment of 0.02 millimetre.

(Refer Slide Time: 21:59)

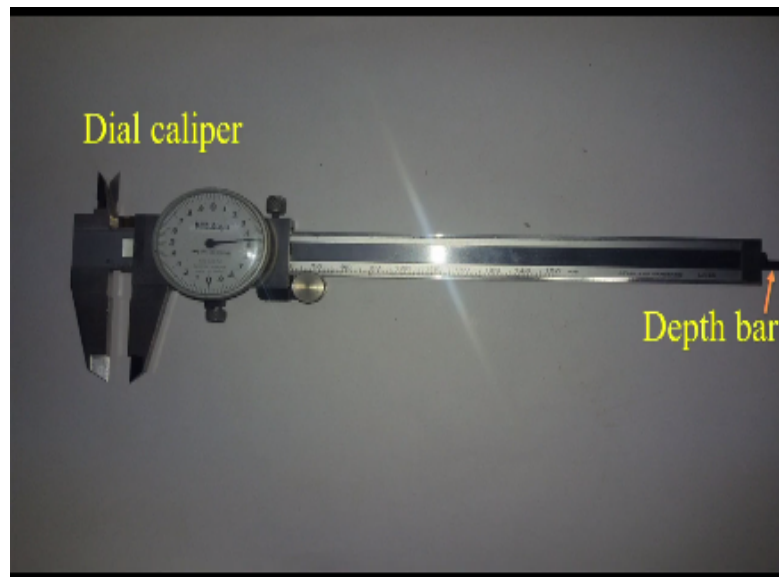

And now we will see what are the variations available in the Vernier caliper. Now the photographs here shows at dial caliper ok instead of vernier what happens if we have to see which graduation on the vernier is coinciding with a graduation in the main scale. So it will take some time for reading and the some effort is required to such that coinciding division.

So that can be eliminated by using a dial caliper, we can see here instead of vernier again we have the main scale with graduations the resolution of the main scale is 1 mm, the range of this instrument is 0-1 mm, see all the parts of the vernier caliper that made out of stainless steel, so that they are not provided and they are properly harden and stabilize, so this process relieve.

Now we can see the base of vernier we have a dial indicator, again we have a knelled knob for moving the jaws, so again this will be use for outside measurement as well as inside measurement and one more thing we observe here we have a depth bar, so when we move the moving jaw the depth bar also will move out, using this moving depth bar and the edge of this beam has reference.

We can always measure depth of the work piece or depth of something big holes or such things can be measured.

(Refer Slide Time: 24:08)

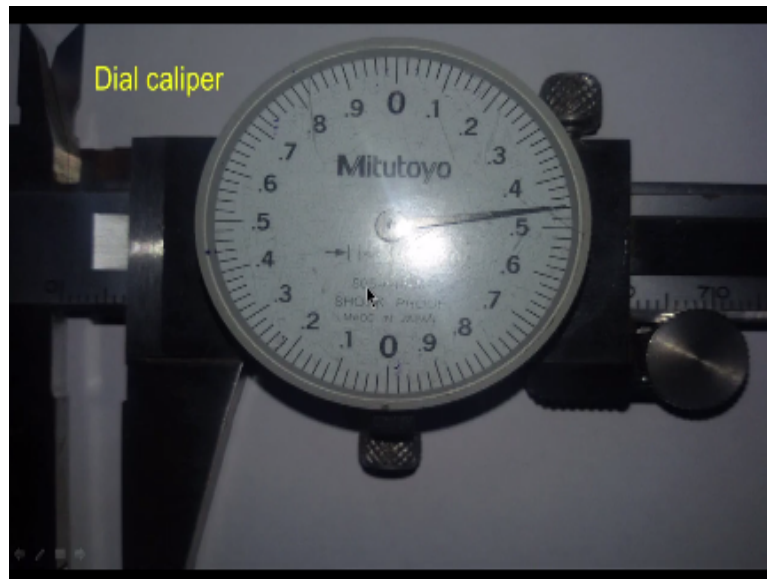

Now we can see a close view of dial caliper, the main scale resolution is 1 mm and we can observe this dial caliper where in the resolution of this dial is 0.02 mm. That means the distance between these 2 unique graduations indicates 0.02 mm, that means if pointer move from this graduation to this graduation it will be 0.1 mm and then for one more complete revolution 0.1 mm, 0.2 mm like this is 1 mm.

The pointer move from 0 to this 0 it will be 1 mm, again the pointer moves from this 0 to this 0 it is 1 mm. That means the work pieces can be measured to an accuracy of 0.02 mm.

(Refer Slide Time: 25:35)

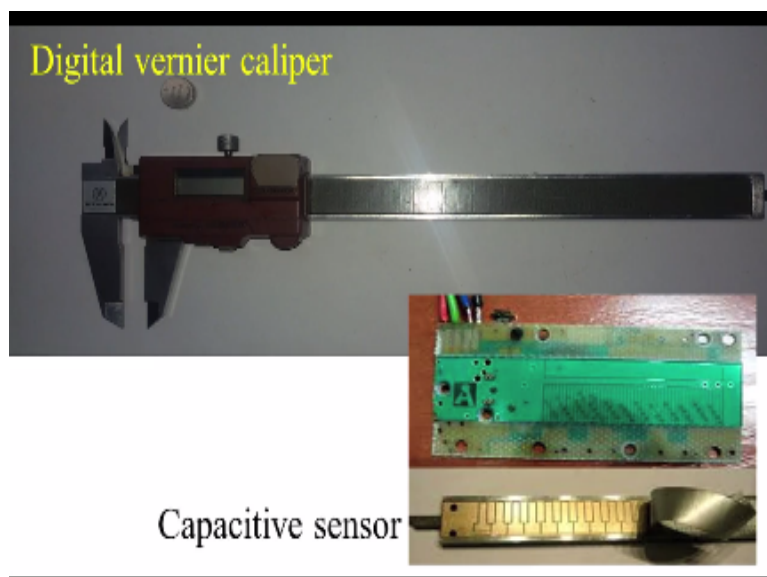

Now we have a digital vernier caliper, we can see here dial or vernier we have digital display. We have digital display here and again screw is provided for clamping the measuring head to the beam at the desire rotation. There is a null knob for moving the machine head. Now we can say the how this senses the movement, so below inside of this beam we have a capacity of sensor there is a protective coating which has main scale. So when the jaw moves, moving the jaw moves the distance mode is sense by using the capacity of the sensor. Again we can see the depth bar here.

(Refer Slide Time: 26:46)



Now this is the close view of the digital display of the digital vernier caliper, and we can there are 2 buttons, so this one is for switching between inches and millimeter. This can use for measurement both in units inch as well as millimeter and this button is provided for stocking the measurement or switching of the head and is there for data transfer to the microprocessor whichever is provided. So that the measurements can be transferred to a computer for control analysis.

(Refer Slide Time: 27:44)

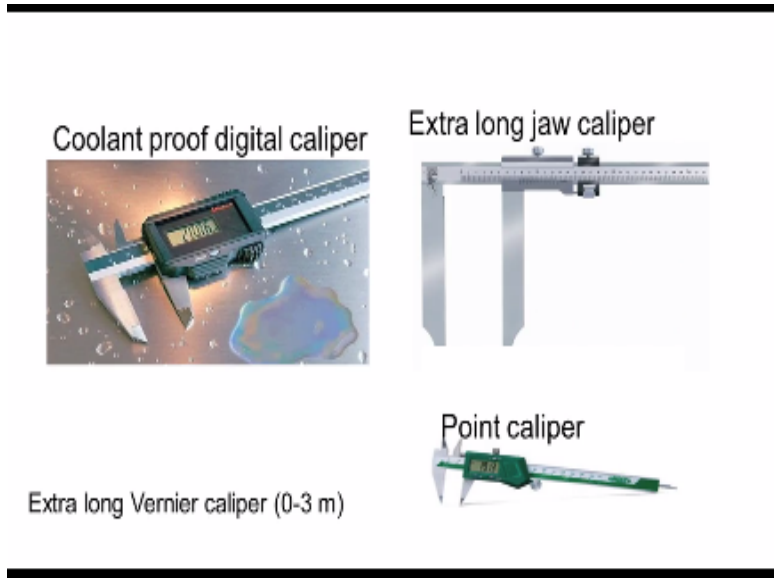

Now there are other kinds of calipers, vernier calipers you can see here, coolant proof digital caliper, sometime what happens that the operator is running the machine is machining some component and then some coolant is continuously applied on the machine jaw. Now during that time e whenever we wants to measure the diameter, he stops the machine and he takes the caliper and tries to measure the diameter of the work piece or he check he wants to measure the diameter the length of the work piece.

During that time the coolant may slash on the instrument. So it may damage the instrument, so recent the coolant proof calipers are developed even for the coolant slashes on the instrument digital caliper and nothing happens, so the proper gaskets are provided on leak proof arrangement is provided and there are also tested in measuring the changes to check whether there are any coolant proof or not.

Now we have extra long jaw caliper, again we can see the beam construct remain the same, anything is difference in the jaw length, so these are extra long jaws. For example sometimes the work piece will be having the some features like this and just drawing a sketch of work piece which is having some internal feature, now with the normal vernier caliper or dial caliper will become difficult to measure this systems.

Because of this depth involved now we can always have an extra long jaw caliper, so that these 2 jaws will enter into the work piece and then we can measure the distance d . Now this length of jaw will be up to 300 millimeter long jaws are available. Similarly this is extra long

caliper, similarly we can have extra long vernier caliper jaw that means that are normal length whereas the beam length.

Beam length will vary up to 3 meters, so such a long calipers one can get. So that they are required to measure big work pieces and then we have point caliper we can observe the measuring jaw ends they are pointed. So these things will be useful for measuring the difficult to access places for example we have work piece like this ok so very narrow grooves we have, now want to measure the distance between these two.

So this distance I want to measure, so normal caliper cannot be used here because of the size of the jaw, so this point end caliper point in caliper can be used in such applications.

(Refer Slide Time: 32:37)

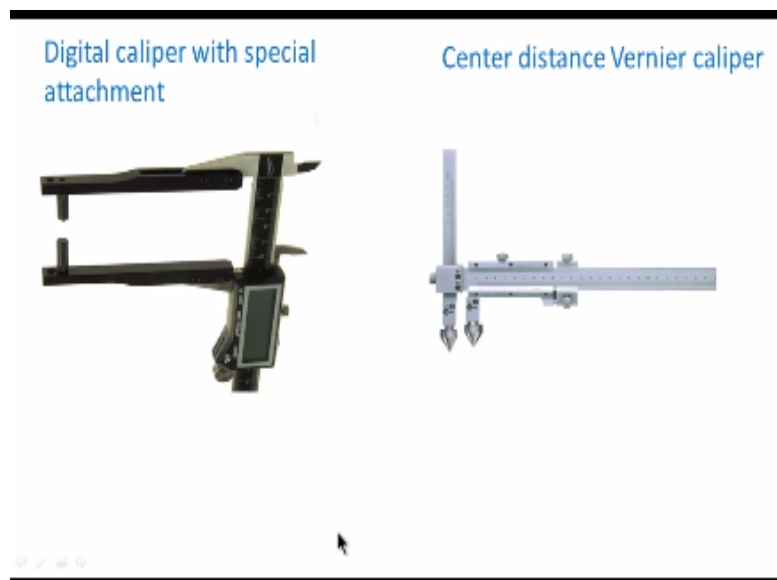

Now there are digital callipers with special attachments, we can see here we have a normal measuring jaw here but with special attachments different kinds of attachments are possible. So such attachments will be useful depend upon the application. For example here we have flat surface and here it is pointed. So if you have work piece like this we use both flat tips then what happens if they contact will be like this.

So here then we get so this will need to some error in measurement, so it is necessary that. point contact, so one jaw or one angle is flattening make a contact point here, and this is pointed, so it will make a point contact and that will go and touch the work piece, so we get the correct measurement. Similarly we can have the centre distance Vernier caliper ok we have the main beam with fine adjustment screw.

And then you can see the jaws have special shapes special (()) (34:27) or cone type cone type jaws are there and then another interesting thing is this moving jaw will move horizontally and this jaw will move vertically, you can see that is a screw for clamping this jaw at any desired location within an screw this second more this along with the scale and then at any desired location clamping.

Now what is the application of this central distance vernier caliper let us draw a simple sketch, now we have work piece like this we have a hole here and then we have another hole here, now I want to know the centre distance between these two poles. Now since the 2 holes, 2 holes are not in the same plane, there this different plane. So we cannot use ordinary Centre distance in that case the special Centre distance Vernier caliper will be of great to be very useful.

So this hole will go here and then this cone will move and then rented here like this and then we can read to Centre distance.

(Refer Slide Time: 36:23)

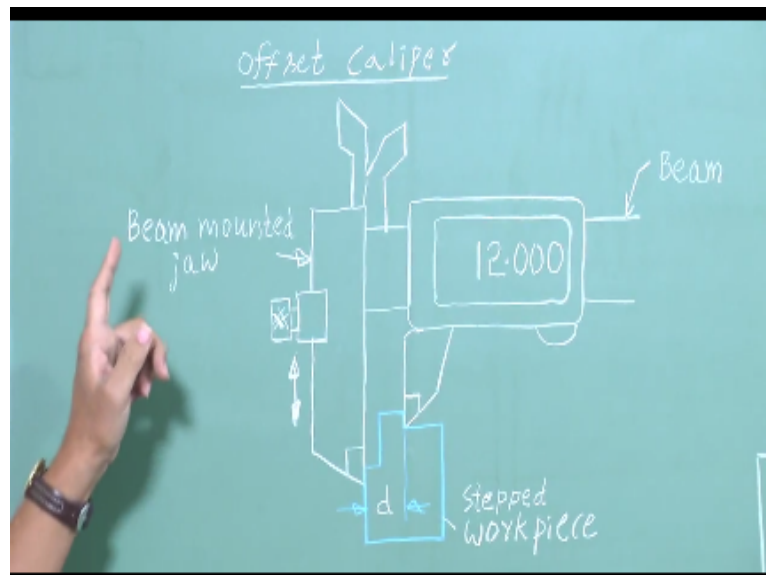

Now we can see other types of calipers, so this is a digital caliper this is offset caliper, now we can see this is the moving jaw and this is the job which is be mounted job so it is mounted on the beam and then it can be moved in the vertical direction and it can be clamped at any desired location using this screw. Now what is the use of such a offset caliper, now I can see here we have stepped work piece we have stepped.

But piece we have stuff here I want to measure the distance between this surface and this surface they are not at the same level so we cannot use the ordinary caliper. So in such cases this offset caliper will be useful we can remove this be mounted jaw so that it will be in contact with this vertical surface and discharge will be in contact with this vertical surface and then we can directly read what is the distance variation of job.

So in this case we have a radius jaws, you can observe the jaws, the jaws have a shape the radius, so such radius jaws will be very useful when they want to measure the internal diameter the holes accurately. So when the use the radius jaws the contact will be proper and contact will be there and we get the correct measurement of the internal dimensions. So if we use flat jaws to measure internal dimension of this time what happens if you can see here the contact is a these two points not at the centre.

So this much will be there get enter get entered forget script in so we do not get the correct inside the dimensions. Now we have the offset centre distance caliper so we have a work piece like this we have a whole here and have another Foley year I want to get the central distance between these two, in such cases of sets at a distance caliper will be very useful. Now we have another kind of arrangement in the caliper I can see here the job or provide in the bottom of the caliper.

And one jaw is having a flat surface and another jaw is conical like see different you here this is a jaw having flat surface, flat measuring surface and here we have a cone shaped jaw, now what is the use of such a such an arrangement now when we have work piece like this there is a hole here I want to know the distance of centre of all with reference to this vertical surface science such cases we can measure the text to Centre distance text to Centre distance using this type of H2 Centre caliper.

(Refer Slide Time: 40:06)

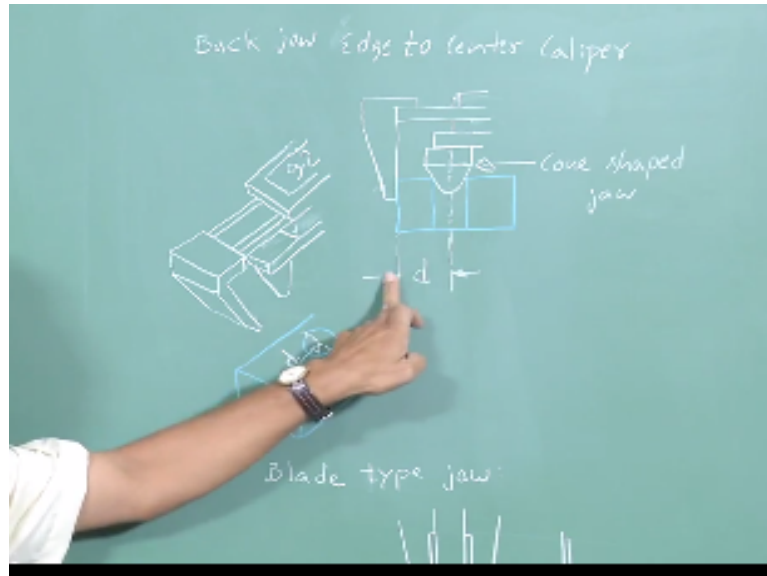

So this jaw will come in contact with this vertical surface report piece and then go on will enter into the hole and we can directly read this distance and there is another variation of caliper, so that is blade type jaw. The caliper will be having blade type jaw you can see the blade type jaw from end we can see the thickness of the blade is 0.75 mm. So what is the use of such an arrangement.

This will be very useful when we wish to measure very narrow grooves, now let us conclude this session. In this session we study about very important instruments that is combination set and then vernier caliper we studied about construction of these instruments and how to use those instruments for various applications and what are the variations by the bill so those things we study. In a next class we will continue the linear measurements, thank you.